



ADT somos una consolidada empresa, creada por profesionales del sector dental con la misión de poner al alcance de nuestros clientes las soluciones más innovadoras en el campo de aditamentos para implantes dentales.

Nuestro equipo de ingenieros trabaja bajo el asesoramiento de reconocidos profesionales del sector dental, lo que nos permite estar a la vanguardia en diseño y fabricación en todos nuestros productos.

Presentes en más de 25 países, en ADT apostamos por el futuro, la calidad y la satisfacción de todos nuestros clientes.

**Calidad garantizada de por vida.**



# FABRICACIÓN ADITAMENTOS

Fabricamos nuestros aditamentos con la más alta tecnología y últimas novedades del sector del mecanizado CNC utilizando maquinaria de última generación.

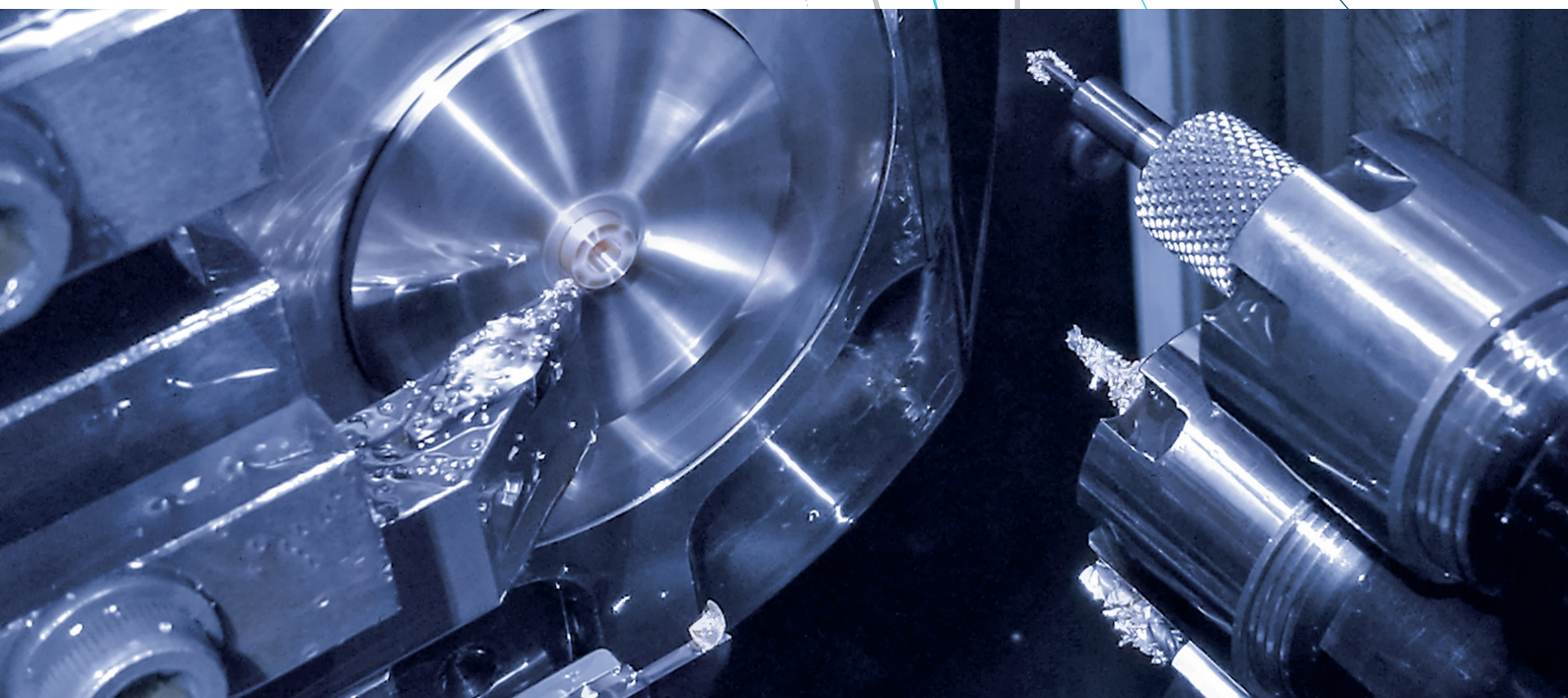

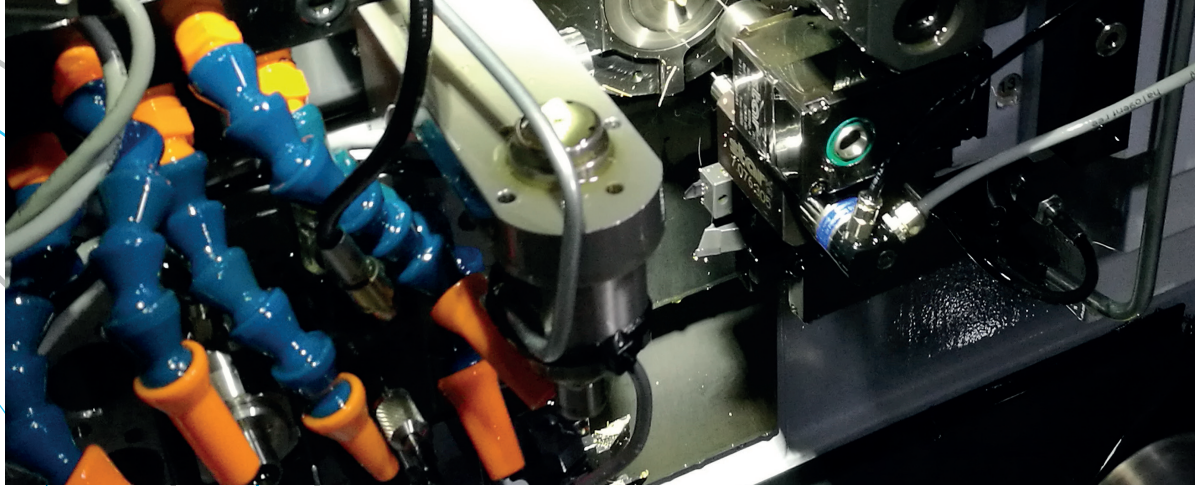

## ADITAMENTOS A MEDIDA

---

Fabricamos aditamentos a medida para cubrir necesidades especiales de nuestros clientes. Nos encargamos de diseñar y fabricar el aditamento que requieres para tus trabajos.

Nuestros ingenieros trabajarán codo con codo contigo en el diseño de tu pieza para garantizar que cumple todos los parámetros y cubre tus necesidades.

---

Consúltanos, estudiaremos la conexión que necesitas y desarrollaremos un proyecto acorde a tus requerimientos.

# CALIDAD

En ADT contamos con los siguientes certificados de calidad que avalan nuestro esfuerzo en mantener la perfección en nuestros productos:

- ISO13485:2016: Gestión de la calidad en la fabricación de dispositivos médicos.
- Marcado CE en todos nuestros productos.
- Licencia AEMPS (Agencia Española de Medicamentos y Productos Sanitarios) para la fabricación productos sanitarios.

El protocolo de trabajo de nuestro departamento de calidad viene marcado por un exhaustivo control visual de todas las piezas, seguido por un minucioso control funcional y dimensional en el que se evalúan las cotas críticas de cada pieza para asegurar el correcto funcionamiento de nuestros aditamentos.

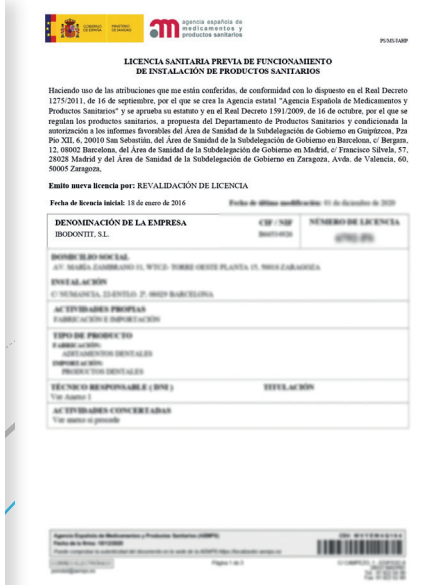



## GARANTÍA

Nuestro compromiso contigo radica en ofrecer la máxima calidad en nuestros productos. Velamos por trabajar siempre con materiales y tratamientos superficiales de las más altas calidades.

Nos ocupamos de todo el proceso de diseño, desarrollo y fabricación de nuestras piezas hasta su puesta en el mercado para ofrecer el mejor producto al profesional implantólogo y/o protésico.

En ADT estamos tan convencidos de la calidad de nuestros productos que están garantizados de por vida.

# AC SCREW SYSTEM

---

El sistema de trabajo sobre canal angulado permite afrontar los casos más complejos en prótesis atornillada, permitiendo mantener una excelente estética y funcionalidad de la prótesis.

Gracias al Tornillo ACS, en combinación con nuestras librerías CAD y con nuestras bases Cr-Co + Chimenea angulada (17° y 30°), es posible realizar trabajos modificando la angulación del canal del tornillo, haciendo posible restauraciones atornilladas que hasta ahora no eran viables.

## PRACTICIDAD

- Exclusividad de geometría tetralobular.
- Imposibilidad de acoplamiento con cualquier otra llave de 4 estrías del mercado.
- Rápida identificación visual en cualquier situación clínica.

## CINEMÁTICA

- Acoplamiento perfecto entre tornillo y llave.
- Mejora el deslizamiento y reduce el riesgo de desacople accidental.

## MECÁNICA

- Estrías más anchas y robustas para reducir riesgo de coronación. Su elevada resistencia genera confianza a la hora de aplicar el torque necesario.
- Aumento del vector de fuerza tangente al giro que ayuda al movimiento de roscado y desenroscado.
- Posibilidad de angulación hasta 30°, generalmente más que suficiente para poder corregir la mayoría de los casos.

**Fabricados en Titanio gr.5 de uso médico y disponibles para la mayoría de sistemas de implantes del mercado**

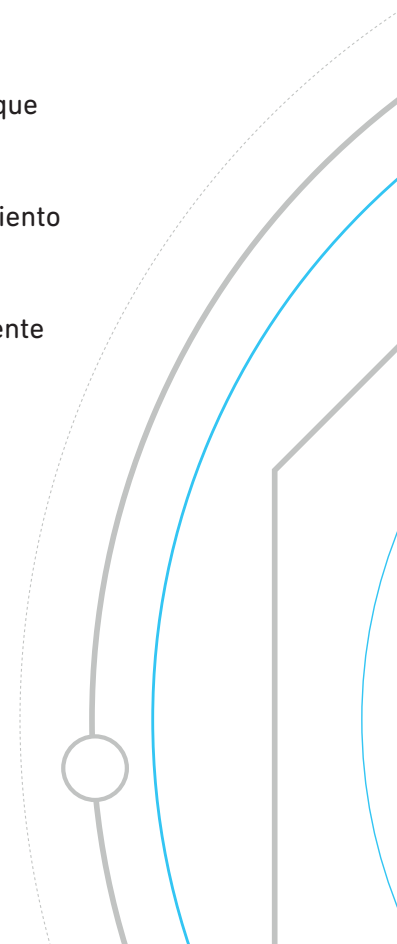

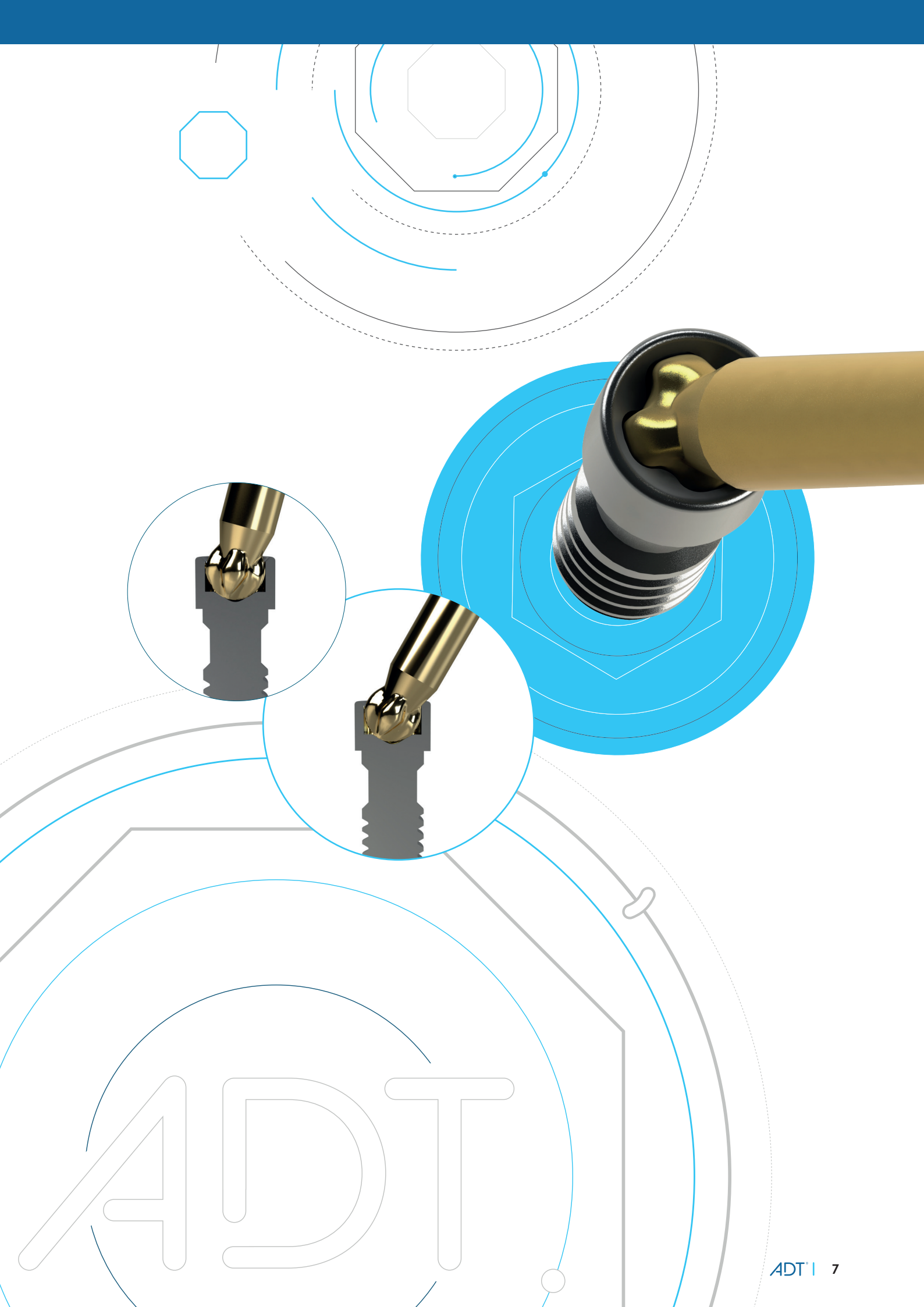

# ANÁLOGOS

Análogos preparados para cualquier uso: convencional y digital para flujo CAD/CAM. Presenta una longitud reducida para facilitar la creación del modelo en clínica frente a los análogos tradicionales y una rosca en la parte inferior para poder fijarlo en el modelo impreso.

También presenta doble ranura y doble cara plana para que quede totalmente inmovilizado en el modelo de escayola.

Librerías CAD a medida.

Personalizamos la librería de análogos digitales para que pueda adaptarse a la resolución de impresión que ofrece su impresora 3D. A través de un patrón de calibración podrá escoger entre 9 configuraciones diferentes (variación de tolerancias) para trabajar con su impresora 3D de la mejor manera posible.

- Ajuste perfecto en modelos 3D fresados e imprimidos.
- Máxima precisión en tolerancias dimensionales.
- Librería CAD/CAM personalizable según la impresora 3D del usuario.
- Tornillo de fijación al modelo.

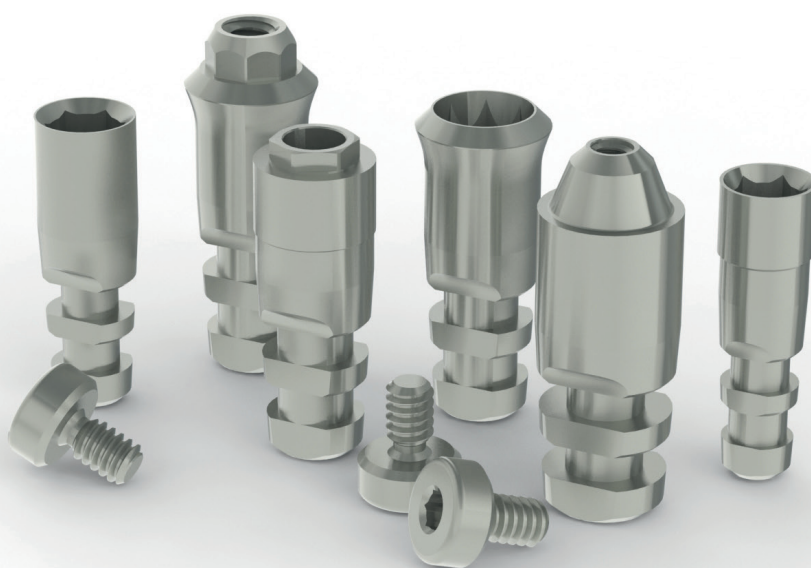
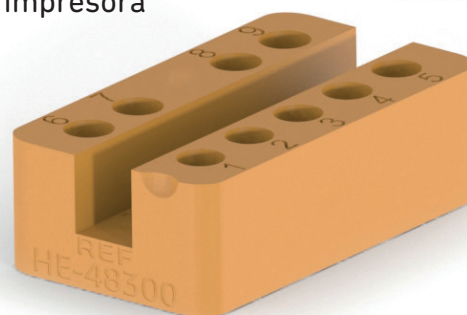
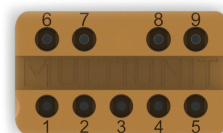



# TORNILLO CON RECUBRIMIENTO PVD

Presentamos la evolución del tornillo de clínica. Tornillos con Recubrimiento WC/C (Carburo de Tungsteno) que elevan sus prestaciones al poder reducir el torque del tornillo y simultáneamente tener un par de apriete mejorado en un 30%, lo que hace que la fijación sea más estable. Recomendado para casos de aflojamiento del tornillo.

## PROPIEDADES:

- Totalmente Hemo y biocompatible al basarse en el carbono.
- Muy resistente a la corrosión.
- Alta resistencia al desgaste.
- Elevada dureza (2.000-5.000 HV).
- Muy bajo coeficiente de fricción (0,1 - 0,01).
- Esterilizable.

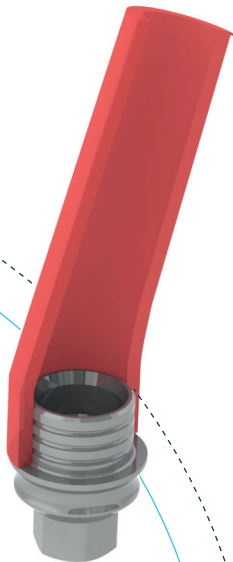

# CHIMENEA ANGULADA

Disponemos de chimeneas para nuestras bases mecanizadas de Cr-Co con dos angulaciones disponibles: 17° y 30°.

Las chimeneas están fabricadas utilizando resinas fotocurables 100% calcinables obteniendo un colado limpio y exacto.

# CAD/CAM - LIBRERÍAS DIGITALES IBO

Las librerías digitales IBO han sido diseñadas en colaboración con los principales desarrolladores de software de diseño dental y ofrecen un amplio abanico de posibilidades CAD/CAM.



Disponibles para trabajos:

- Implant Level (fresado directo a implante o sinterizado + re-mecanizado).
- Interfases con sus diferentes alturas gingivales y alturas de cementación.
- Bases mecanizadas de Cr-Co.
- Pilares provisionales con sus diferentes alturas cementables.
- Análogos digitales para modelos 3D.

En todos los casos se incluye la posibilidad de trabajar con Scanbodies de laboratorio (Peek) o intraorales (titanio) y de igual manera están preparados para trabajar tanto canal recto como canal angulado.

Todas nuestras librerías están certificadas y validadas por desarrolladores de software CAM.



Disponemos de un amplio catálogo de librerías, que hacen posible diseñar todo tipo de trabajos: fresados directo a implante, sinterizado + re-mecanizado, bases de titanio o sobre bases de Cr-Co.

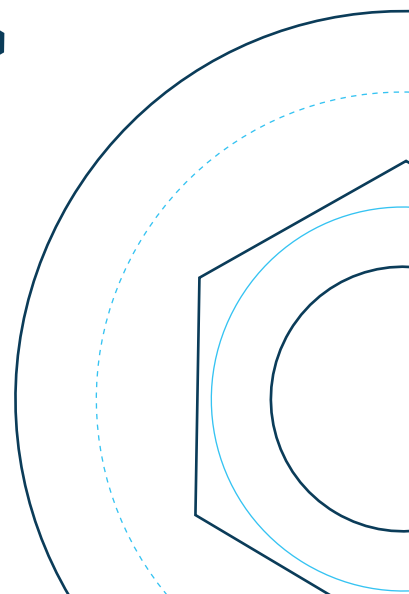
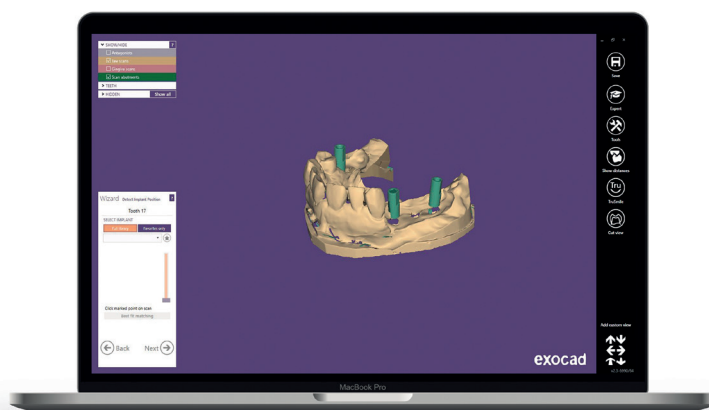

## INTERFASE AC 2G

Diseñada para corregir angulaciones en combinación con el tornillo angulado ACS. Disponen de una ventana para acceder a la cabeza del tornillo hasta la profundidad máxima de atornillado. Su estudiado diseño permite grosores adecuados de cerámica o zirconio para unos resultados funcionales óptimos, sin comprometer la fatiga del sistema.

Diseño cónico para restauraciones múltiples y doble cara plana en vestibular y palatino.

Diferentes alturas gingivales para los principales sistemas de implantes para facilitar la adaptación de la encía.

Librerías digitales disponibles para todos los software CAD dentales.



## INTERFASE 3G

La interfase 100% digital. Especialmente concebida para la cementación sin modelo. Gracias a su novedoso diseño, la interfase 3G facilita el fresado de la corona, proporcionando un ajuste óptimo.

Mejora el sellado con la prótesis asegurando un asiento libre de cemento y una suave transición a la prótesis.

Diferentes alturas gingivales para los principales sistemas de implantes para facilitar la adaptación de la encía.

Diferentes alturas de cementación (7, 5 y 3mm) en librerías CAD.

Disponemos de librerías con opciones especiales que aprovechan al máximo las ventajas de la fabricación por impresión 3D.

Recubrimiento: TiN.



## SCANBODY

---

- Scanbody de laboratorio: Scanbody de  $\varnothing 5.5\text{mm}$  para aumentar la superficie cilíndrica y de las caras planas para tener una mayor definición en el escaneado. Está diseñado para trabajar perfectamente sobre modelos convencionales.

Pieza monobloque fabricado íntegramente de Peek. Esta característica permite que no haya divergencias entre acoplamientos entre piezas al estar fabricado de una sola pieza.

- Scanbody Intraoral: El scanbody intraoral tiene una altura y diámetro más reducida para facilitar su colocación en boca y un diámetro similar a la conexión. Pieza monobloque, no genera divergencia en su acoplamiento.

Fabricado íntegramente de titanio, permite su visualización a través de rayos X y verificar su asentamiento. El scanbody intraoral está tratado con nitruro de zirconio (ZrN) aportando una superficie mate que facilita la lectura con el escáner, evitando el uso de sprays.

- Longitud reducida para facilitar su uso en boca.
- Visibles a través de RX para comprobar el asentamiento correcto con el implante.
- Mismo diámetro que la conexión.
- Tornillo de sujeción prisionero.
- Fabricados íntegramente de titanio grado 5 de uso médico con tratamiento superficial de Nitruro de Zirconio (ZrN) para una lectura perfecta.

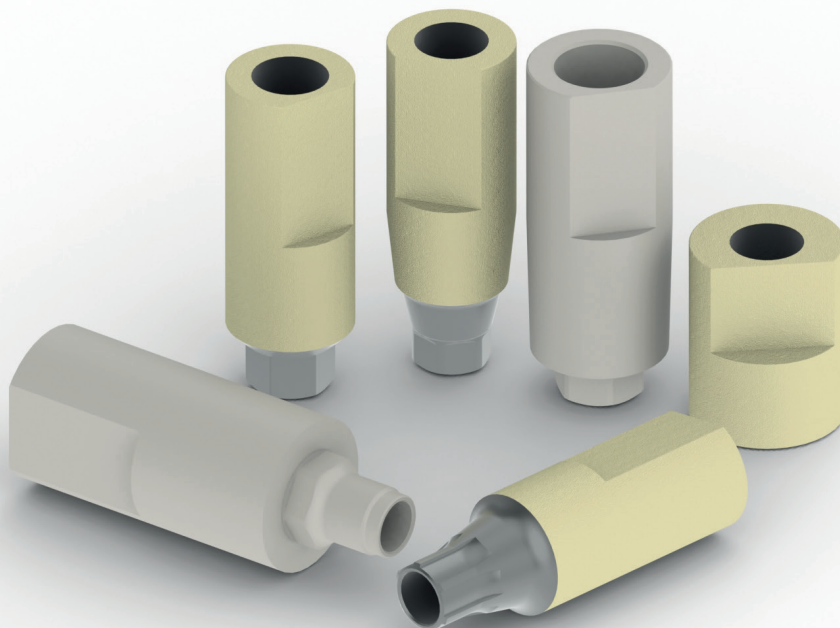

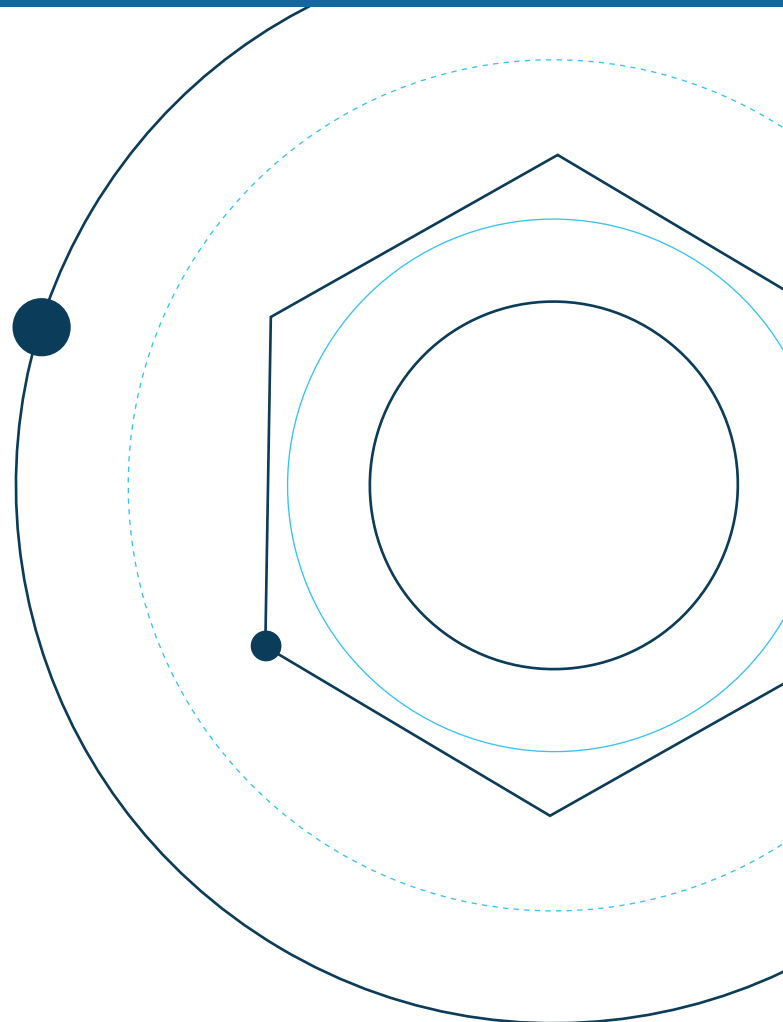

## LOCK-ATTACH

La solución perfecta para sobre dentaduras removibles.

El pilar Lock-Attach está tratado superficialmente con Nitruro de Titanio (TiN), lo que aporta resistencia al desgaste y evita el ataque bacteriano.











Disponible en diferentes alturas para la correcta adaptación al tejido gingival circundante.

Para determinar el esfuerzo de extracción de la sobre dentadura existen diferentes referencias para obtener una dureza de retención determinada en cada caso.

- Mayor resistencia al desgaste abrasivo: hasta 2400 vickers de dureza.
- Reduce el coeficiente de fricción.
- Mayor resistencia contra la fatiga. Evita holguras por desgaste.
- Test de Biocompatibilidad, FDA, test de citotoxicidad, irritación y sensibilización superados.
- Recubrimiento barrera, lo que evita la liberación de iones (ion leaching).
- Evita que se adhieran restos orgánicos. Reduce la actividad bacteriana.



# ÍNDICE

	<b>FLUJO MULTIUNIT</b>				18 - 19
	<b>FLUJO LOCK-ATTACH</b>				21 - 21
	<b>NOBEL BIOCARE®</b>				
	HE	CAD/CAM 1100	BRANEMARK®	∅ 3.5 / ∅ 4.1 / ∅ 5.1	24 - 27
	HEZ	CAD/CAM 1300	REPLACE®	∅ 3.5 / ∅ 4.3 / ∅ 5.0	28 - 29
	HEC	CAD/CAM 1400	ACTIVE®	∅ 3.0 / ∅ 3.5 / ∅ 4.3	30 - 33
	<b>ZIMMER®</b>				
	HEI	CAD/CAM 1500	SCREW VENT®	∅ 3.5 / ∅ 4.5 / ∅ 5.7	36 - 39
	<b>STRAUMANN®</b>				
	HI	CAD/CAM 1800	TISSUE LEVEL®	∅ 4.8 RN / ∅ 6.5 WN	42 - 45
	HI	CAD/CAM 1900	BONE LEVEL®	∅ 3.3 NC / ∅ 4.1 RC	46 - 47
		CAD/CAM 3800	BLX®	RB / WB	48 - 49
	<b>ASTRA TECH®</b>				
	HEA	CAD/CAM 2000	OSSEOSPEED Tx®	∅ 3.0 / AQUA ∅ 3.5 - ∅ 4.0 LILAC ∅ 4.5 - ∅ 5.0	52 - 55
		CAD/CAM 3200	EV®	∅ 3.0 / ∅ 3.6 / ∅ 4.2 / ∅ 4.8	56 - 57
	<b>BIOMET 3i®</b>				
	HE	CAD/CAM 2100	HEX. EXTERNO®	∅ 3.25 / ∅ 4.1 / ∅ 5.0	60 - 63
	HEW	CAD/CAM 2200	CERTAIN®	∅ 3.4 / ∅ 4.1 / ∅ 5.0	64 - 65
	<b>MIS®</b>				
	HEM	CAD/CAM 1700	SEVEN®	∅ 3.3 NP, SP, WP	68 - 71
		CAD/CAM 4000	C1/V3®	SP	72 - 73
	<b>SWEDEN &amp; MARTINA®</b>				
	HES	CAD/CAM 2700	PREMIUM KOHNO®	∅ 3.3 / ∅ 3.8 / ∅ 4.25 / ∅ 5.0	76 - 77
	<b>KLOCKNER®</b>				
	HEV	CAD/CAM 2300	SK2-NK2®	∅ 4.2	80 - 81
	HEV	CAD/CAM 2400	ESSENTIAL®	∅ 4.5	82 - 83
		CAD/CAM4100	VEGA®	∅ 3.5 / ∅ 4.0 / ∅ 4.5	84 - 85
	<b>BIOHORIZONS®</b>				
	HEI	CAD/CAM 1600	TAPERED INTERNAL®	∅ 3.0 / ∅ 3.5 / ∅ 4.5	88 - 91

 **DENTSPLY®**

CAD/CAM 3100	FRIADENT XIVE®	∅ 3.4 / ∅ 3.8 / ∅ 4.5	94 - 95
CAD/CAM 3500	ANKYLOS®	C/X	96 - 97

 **BTI®**

CAD/CAM 2600	HEX. EXTERNO®	∅ 3.5 / ∅ 4.1	100 - 101
HEB CAD/CAM 2500	INTERNA®	∅ 4.1 UNIVERSAL / ∅ 5.5 ANCHA	102 - 103

 **MICRODENT®**

CAD/CAM 3300	SYSTEM®	∅ 4.2 / ∅ 5.1	106 - 107
--------------	---------	---------------	-----------

 **PHIBO®**

HPH CAD/CAM 2900	TSH®	S2 / S3-S4	110 - 111
------------------	------	------------	-----------

 **NEODENT®**

CAD/CAM 3400	CM CONO MORSE®	∅ 3.5	114 - 115
CAD/CAM 3600	GM GRAND MORSE®	∅ 3.5 / ∅ 3.75 / ∅ 4.0 / ∅ 4.3 / ∅ 5.0 / ∅ 6.0	116 - 117

 **OSSTEM®**

CAD/CAM 3000	TS SYSTEM®	REGULAR	120 - 121
--------------	------------	---------	-----------

 **BEGO®**

CAD/CAM 3900	SC/RS®	∅ 3.25 / ∅ 3.75 / ∅ 4.1 / ∅ 4.5	124 - 125
--------------	--------	---------------------------------	-----------

 **MEGAGEN®**

CAD/CAM 3700	ANYRIDGE®	∅ 4.0	128 - 129
--------------	-----------	-------	-----------

 **DESTORNILLADORES**

132 - 133

 **INSTRUMENTAL Y LLAVES**

134 - 135

 **ESPECIFICACIONES TORNILLO  
CANAL RECTO**

136 - 139

 **ESPECIFICACIONES TORNILLO  
CANAL ANGULADO**

140 - 143

Los aditamentos suministrados por Ibdontit S.L. son compatibles con diferentes sistemas de implantes. El objetivo de mencionar las marcas es meramente informativo, a fin de identificar aquellas conexiones con las que los aditamentos de IBO son compatibles. Las imágenes de las referencias aquí mostradas no guardan valor contractual.





# FLUJOS DE TRABAJO

ADT<sup>®</sup>  
AXUS  
DENTAL  
TECH



# FLUJO MULTIUNIT

RP Ø4.8

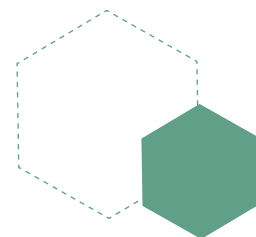

**RP Ø4.8**



## Análogo

Rotatorio	HE-48300
Antirrotatorio	HE-48310
Estheticone	HE-48350



## Tornillo análogo digital

M1,6 hex. 1,20	HE-41215
----------------	----------



## Transfer de impresión

Rotatorio - Cubeta abierta (CA)	HE-48700
Rotatorio - Cubeta cerrada (CC)	HE-48710
Antirrotatorio - Cubeta abierta (CA)	HE-48703

Cubeta abierta (CA) Estheticone	HE-48701
Tornillo copying CA	HE-48702



## Tapón de cicatrización

POM	HE-48620
Titanio (Tornillo Incl.)	HE-48621
Titanio (Tornillo Incl.) Estheticone	HE-48623



## Tornillo

M1.4 Unigrip	HE-48200
M1.4 Unigrip DLC	HE-48280
M1.4 Unigrip Oro	HE-48206
M1.4 c/hex. 1,27	HE-48201

M1,4 Tetralobular ACS	IBO 1201 225
-----------------------	--------------



## Calcinable

Rotatorio	HE-48010
Rotatorio Estheticone	HE-48050

**RP Ø4.8**



**Calcinable base Cr-Co**

Rotatorio  
Antirrotatorio

HE-48100  
HE-48110



**Chimenea angulada base Cr-Co**

17°  
30°

IBO 1102 011  
IBO 1102 012



**Pilar provisional**

Rotatorio  
Rotatorio Peek  
Rotatorio Estheticone  
Antirrotatorio  
Rotatorio tipo Tibase  
Antirrotatorio tipo Tibase

HE-48610  
HE-48613  
HE-48611  
HE-48614  
HE-48615  
HE-48616



**Scanbody**

Intraoral titanio rotatorio  
Intraoral titanio antirrotatorio  
Laboratorio rotatorio

IBO 1201 702  
IBO 1201 703  
HE-48770



**Intefase 1G**

Rotatorio  
Antirrotatorio

HE-48750  
HE-48751



**Interfase AC 2G**

Rotatorio

IBO 1201 621



**Pilar Lock-Attach**

Alt. 3mm

HE-48903

# FLUJO LOCK-ATTACH

MULTISISTEMA

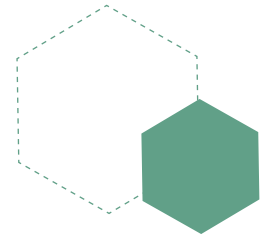

## MULTISISTEMA



### Análogo

HE-41911



### Transfer de impresión

Pack (4ud)

HE-41920



### Casquillo calcinable para barra

Pack (4ud)

HE-41930



### Transportador para pilar

HE-41912



### SET Protésico

HE-41910

### Componentes



Set retención azul 1.5 lbs (5 ud)

HE-41913



Set retención rosa 3 lbs (5 ud)

HE-41914



Set retención blanca 5 lbs (5 ud)

HE-41915



Set retención roja 1.5 lbs (5 ud)

HE-41916



Set retención negra Lab. (5 ud)

HE-41917



Set cazoletas Lock-Attach (5 ud)

HE-41918



Set aro Lock-Attach (5 ud)

HE-41919



### Pilar Lock-Attach para barra

HE-41909

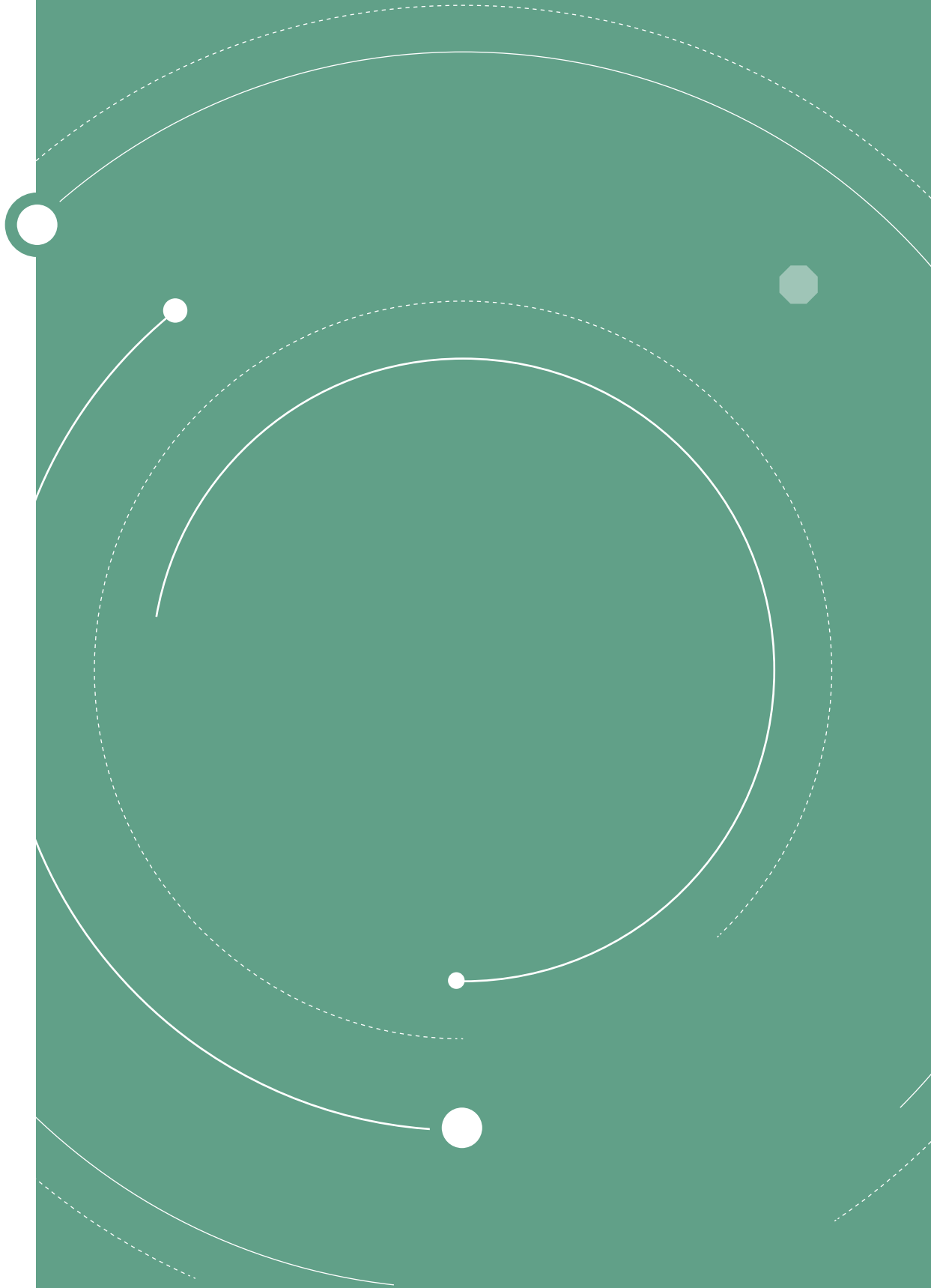



# NOBEL BIOCARE®

**HE** CAD/CAM 1100  
BRANEMARK®

**HEZ** CAD/CAM 1300  
REPLACE®

**HEC** CAD/CAM 1400  
ACTIVE®

---

Ibodontit S.L. no guarda relación con ninguna de las marcas aquí referenciadas,  
que son propiedad de sus respectivos titulares

---

**ADT**®  
AXUS  
DENTAL  
TECH



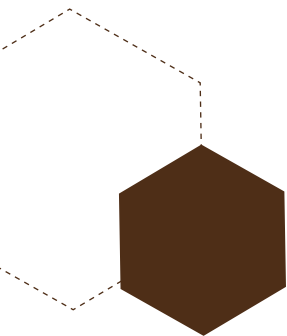





















# NOBEL BIOCARE<sup>®</sup> BRANEMARK<sup>®</sup>

Ø3.5 / Ø4.1 / Ø5.1



	<i>NP Ø3.5</i>	<i>RP Ø4.1</i>	<i>WP Ø5.1</i>
	<b>Análogo</b>		
	HE-35300	HE-41300	HE-51301
	<b>Tornillo análogo digital</b>		
M1,6 hex. 1,20	HE-41215	HE-41215	HE-41215
	<b>Transfer de impresión</b>		
Cubeta abierta (CA)	HE-35700	HE-41700	HE-51702
Cubeta cerrada (CC)		HE-41710	
Tornillo transfer CA		HE-41701	
Tornillo transfer CC		HE-41711	
	<b>Tapón de cicatrización</b>		
Alt. 2mm		HE-41402	
Alt. 3mm	HE-35403	HE-41403	HE-51413
Alt. 4mm		HE-41404	
Alt. 5mm	HE-35405	HE-41405	HE-51415
	<b>Tornillo</b>		
M1,6 Unigrip	HE-35200		
M1,6 Unigrip DLC	HE-35280		
M2 hex. 1,20		HE-41200	
M2 hex. 1,20 DLC		HE-41280	
M2 hex. 1.2 as. plano		HE-41201	
M2 cuadrada 1.30		HE-41202	
M2 hex. 1.25		HE-41203	
M2 hex. 1.20 plana		HE-41204	
M2 Autoblocante c/hex. 1.25		HE-41205	
M2 Tornillo Oro c/hex.1.20		HE-41206	
M2 Unigrip		HE-41207	
M2 c/hex. 1.20 (rosca total)		HE-41208	
M2 cierre		HE-41210	
M2,5 Unigrip			HE-51200
M2,5 Unigrip DLC			HE-51280
<b>M1,6 Tetralobular ACS</b>	IBO 1101 225		
<b>M2 Tetralobular ACS</b>		IBO 1102 225	
<b>M2,5 Tetralobular ACS</b>			IBO 1103 225



	<i>NP Ø3.5</i>	<i>RP Ø4.1</i>	<i>WP Ø5.1</i>
	<b>Calcincible</b>		
Antirrotatorio	HE-35001	HE-41001	HE-51002
Rotatorio	HE-35010	HE-41010	HE-51011
	<b>Calcincible base Cr-Co</b>		
Antirrotatorio	HE-35110	HE-41110	HE-51110
Rotatorio	HE-35100	HE-41100	HE-51100
	<b>Chimenea angulada base Cr-Co</b>		
17°	IBO 1102 011	IBO 1102 011	IBO 1102 013
30°	IBO 1102 012	IBO 1102 012	
	<b>Pilar provisional</b>		
Antirrotatorio	HE-35600	HE-41600	HE-51601
Rotatorio	HE-35610	HE-41610	HE-51611
	<b>Pilar recto / angulado</b>		
Antirrotatorio	HE-35500	HE-41500	
Rotatorio	HE-35550	HE-41550	
Ang. 15°		HE-41650	
Ang. 25°		HE-41651	
	<b>Ball Attach</b>		
Ø1.8 alt. 2mm		HE-41552	
Ø1.8 alt. 3mm		HE-41553	
Ø2.5 Basculante alt. 2mm		109BRK2R	
Ø2.5 Basculante alt. 3mm		109BRK3R	
Ø2.5 Basculante alt. 4mm		109BRK4R	
	<b>Kit Retenciones Ø1.8</b>		
		192ACM	
	Kit Ret. Normal (1100 gr) Ø1.8 (6ud)	040CRM	
	Kit Ret. Suave (900 gr) Ø1.8 (6ud)	040CRMSN	
	Kit Retenciones para Ø 2.5	192ACN	
	Kit Ret Normal (1300 gr) Ø2.5 (6ud)	040CRN	
	Kit Ret Suave (900 gr) Ø2.5 (6ud)	040CRNSN	
	Anillos Direccionales	100AD	
	<b>Scanbody</b>		
Intraoral titanio	IBO 1101 702	IBO 1102 702	IBO 1103 702
Laboratorio Peek	HE-35770	HE-41770	HE-51771
	<b>Interfase 1G</b>		
Antirrotatoria		HE-41751	
Rotatoria		HE-41750	



	NP Ø3.5	RP Ø4.1	WP Ø5.1
<b>Interfase AC 2G</b>			
Antirrotatoria alt. 0,5 mm	IBO 1101 620	IBO 1102 620	IBO 1103 620
Antirrotatoria alt. 1,5 mm		IBO 1102 622	
Antirrotatoria alt. 2,5 mm		IBO 1102 624	
Rotatoria alt. 0,5 mm	IBO 1101 621	IBO 1102 621	IBO 1103 621
Rotatoria alt. 1,5 mm		IBO 1102 623	
Rotatoria alt. 2,5 mm		IBO 1102 625	



<b>Interfase 3G</b>			
Antirrotatoria alt. 0,5 mm	HE-35741	HE-41741	
Antirrotatoria alt. 1,5 mm	HE-35743	HE-41743	
Antirrotatoria alt. 2,5 mm	HE-35745	HE-41745	
Rotatoria alt. 0,5 mm	HE-35740	HE-41740	
Rotatoria alt. 1,5 mm	HE-35742	HE-41742	
Rotatoria alt. 2,5 mm	HE-35744	HE-41744	



<b>Pilar Multiunit</b>			
Alt. 1mm	HE-35801	HE-48801	HE-51801
Alt. 2mm	HE-35802	HE-48802	HE-51802
Alt. 3mm	HE-35803	HE-48803	HE-51803
Alt. 4mm		HE-48804	
Alt. 5mm		HE-48805	
Alt. 7mm con tornillo		HE-48807	
ZIGOMATICO+Tornillo alt. 1 mm		HE-48861	
ZIGOMATICO+Tornillo alt. 2 mm		HE-48862	
ESTHETICONE+Tornillo alt. 1 mm		HE-48871	
ESTHETICONE+Tornillo alt. 2 mm		HE-48872	
ESTHETICONE+Tornillo alt. 3 mm		HE-48873	



<b>Pilar Multiunit angulado</b>			
17° alt. 2mm	HE-35852	HE-48852	
17° alt. 3mm	HE-35853	HE-48853	
17° alt. 4mm		HE-48854	
30° alt. 3mm	HE-35863	HE-48863	
30° alt. 4mm	HE-35864	HE-48864	
30° alt. 5mm		HE-48865	



<b>Pilar Lock-Attach</b>			
Alt. 0,73mm	HE-35901	HE-41901	HE-51901
Alt. 2mm	HE-35902	HE-41902	HE-51902
Alt. 3mm	HE-35903	HE-41903	HE-51903
Alt. 4mm	HE-35904	HE-41904	HE-51904
Alt. 5mm	HE-35905	HE-41905	HE-51905
Alt. 6mm		HE-41906	



Angulado alt. 1,5mm		HE-41951	
Angulado alt. 3mm		HE-41953	

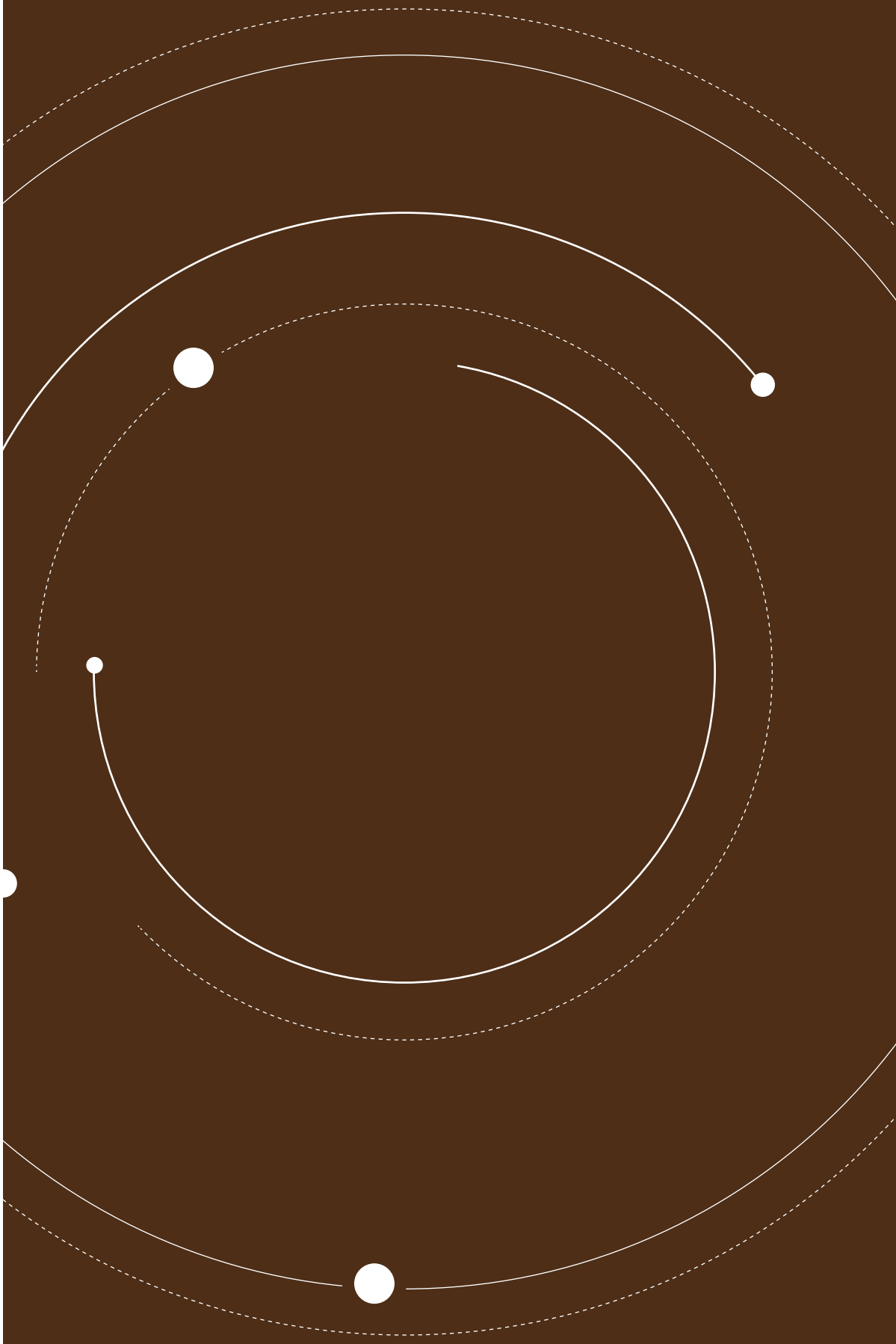







# NOBEL BIOCARE® REPLACE®

Ø3.5 / Ø4.3 / Ø5.0



	<i>NP Ø3.5</i>	<i>RP Ø4.3</i>	<i>WP Ø5.0</i>
	<b>Análogo</b>		
	HEZ-35300	HEZ-43300	HEZ-50300
	<b>Tornillo análogo digital</b>		
M1,6 hex. 1,20	HE-41215	HE-41215	HE-41215
	<b>Transfer de impresión</b>		
Cubeta abierta (CA)	HEZ-35700	HEZ-43700	HEZ-50700
	<b>Tapón de cicatrización</b>		
Alt. 3mm Alt. 5mm	HEZ-35403 HEZ-35405	HEZ-43403 HEZ-43405	HEZ-50403 HEZ-50405
	<b>Tornillo</b>		
M1,8 Unigrip M2 Unigrip	HEZ-35200	HEZ-43200	HEZ-43200
M1,8 Tetralobular ACS M2 Tetralobular ACS	IBO 1301 225	IBO 1302 225	IBO 1302 225
	<b>Calcinable</b>		
Antirrotatorio Rotatorio	HEZ-35001 HEZ-35010	HEZ-43001 HEZ-43010	HEZ-50001 HEZ-50010
	<b>Calcinable base Cr-Co</b>		
Antirrotatorio Rotatorio	HEZ-35110 HEZ-35100	HEZ-43110 HEZ-43100	HEZ-50110 HEZ-50100
	<b>Chimenea angulada base Cr-Co</b>		
17° 30°	IBO 1102 011 IBO 1102 012	IBO 1102 013	IBO 1102 013

	<i>NP Ø3.5</i>	<i>RP Ø4.3</i>	<i>WP Ø5.0</i>
	<b>Pilar recto</b>		
Antirrotatorio 1mm para cementar	HEZ-35510	HEZ-43510	HEZ-50510
	<b>Pilar provisional</b>		
Antirrotatorio	HEZ-35600	HEZ-43600	HEZ-50600
Rotatorio	HEZ-35610	HEZ-43610	HEZ-50610
	<b>Scanbody</b>		
Intraoral titanio	IBO 1301 702	IBO 1302 702	IBO 1303 702
Laboratorio Peek	HEZ-35770	HEZ-43770	HEZ-50770
	<b>Interfase AC 2G</b>		
Antirrotatoria	IBO 1301 620	IBO 1302 620	IBO 1303 620
Rotatoria	IBO 1301 621	IBO 1302 621	IBO 1303 621
	<b>Pilar Multiunit</b>		
Alt. 1mm	HEZ-35801	HEZ-43801	HEZ-50801
Alt. 2mm	HEZ-35802	HEZ-43802	HEZ-50802
Alt. 3mm	HEZ-35803	HEZ-43803	HEZ-50803
Alt. 4mm		HEZ-43804	
Alt. 5mm		HEZ-43805	
	<b>Pilar Multiunit angulado</b>		
17° alt. 2mm		HEZ-43852	
17° alt. 3mm		HEZ-43853	
17° alt. 4mm		HEZ-43854	
30° alt. 4mm		HEZ-43864	
30° alt. 5mm		HEZ-43865	
	<b>Pilar Lock-Attach</b>		
Alt. 0mm	HEZ-35900	HEZ-43900	
Alt. 1mm	HEZ-35901	HEZ-43901	HEZ-50901
Alt. 2mm	HEZ-35902	HEZ-43902	HEZ-50902
Alt. 3mm	HEZ-35903	HEZ-43903	HEZ-50903
Alt. 4mm	HEZ-35904	HEZ-43904	HEZ-50904
Alt. 5mm	HEZ-35905	HEZ-43905	HEZ-50905
Alt. 6mm	HEZ-35906	HEZ-43906	

# NOBEL BIOCARE® ACTIVE®

Ø3.0 / NP Ø3.5 / RP Ø4.3

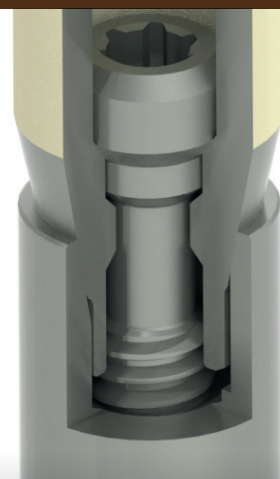

## Análogo

Minipilar MultiUnit

	Ø3.0	NP Ø3.5	RP Ø4.3
	HEC-30300	HEC-35300 HEC-35301	HEC-43300



## Tornillo análogo digital

M1,6 hex. 1,20

	HE-41215	HE-41215	HE-41215
--	----------	----------	----------



## Transfer de impresión

Cubeta abierta (CA)  
Tornillo transfer CA  
Cubeta abierta minipilar MultiUnit

	HEC-30700 HEC-30701	HEC-35700 HEC-35720	HEC-43700
--	------------------------	------------------------	-----------



## Tapón de cicatrización

Alt. 1,5mm  
Alt. 2,5mm  
Alt. 3mm  
Alt. 3,5mm  
Alt. 4,5mm  
Alt. 5mm  
Alt. 5,5mm  
Alt. 7mm  
Minipilar MultiUnit

		HEC-35401 HEC-35402	
	HEC-30403		HEC-43403
		HEC-35403 HEC-35404	
	HEC-30405		HEC-43405
		HEC-35405	HEC-43407
		HEC-35450	



## Tornillo

M1,4 hex. 1.20  
M1,6 Unigrip  
M1.6 Unigrip DLC  
M2 Unigrip  
M2 Unigrip DLC  
M1.6 Unigrip oro  
M2 Unigrip oro  
Tornillo de cierre

	HEC-30200		
		HE-35200 HE-35280	
			HEC-43200 HEC-43280
		HEC-35206	
	HEC-30210	HEC-35210	HEC-43206 HEC-43210

**M1,6 Tetralobular ACS**  
**M2 Tetralobular ACS**









	IBO 1401 225		IBO 1402 225
--	--------------	--	--------------



## Calcinable

Antirrotatorio  
Rotatorio  
Minipilar MultiUnit

	HEC-30001	HEC-35001 HEC-35010 HEC-35011	HEC-43001 HEC-43010
--	-----------	-------------------------------------	------------------------

	<b>Ø3.0</b>	<b>NP Ø3.5</b>	<b>RP Ø4.3</b>
	<b>Calcinable base Cr-Co</b>		
Antirrotatorio	HEC-30110	HEC-35110	HEC-43110
Rotatorio		HEC-35100	HEC-43100
	<b>Chimenea angulada base Cr-Co</b>		
17°		IBO 1102 011	IBO 1102 013
30°		IBO 1102 012	IBO 1102 014
	<b>Pilar provisional</b>		
Antirrotatorio	HEC-30600	HEC-35600	HEC-43600
Rotatorio		HEC-35610	HEC-43610
Antirrotatorio de peek	HEC-30601		
Minipilar MultiUnit		HEC-35620	
	<b>Pilar recto / angulado</b>		
Antirrotatorio alt. 7mm	HEC-30507		
Antirrotatorio alt. 9mm	HEC-30509		
15°	HEC-30650		
	<b>Scanbody</b>		
Intraoral titanio	IBO 0301 702	IBO 1401 702	IBO 1402 702
Laboratorio Peek		HEC-35770	HEC-43770
Minipilar Multiunit		HEC-35771	
	<b>Interfase 1G</b>		
Antirrotatoria	HEC-30751	HEC-35751	HEC-43751
Rotatoria		HEC-35750	HEC-43750
	<b>Interfase AC 2G</b>		
Antirrotatoria alt. 1mm		IBO 1401 620	IBO 1402 620
Antirrotatoria alt. 2mm		IBO 1401 622	IBO 1402 622
Antirrotatoria alt. 3mm		IBO 1401 624	IBO 1402 624
Rotatoria alt. 1mm		IBO 1401 621	IBO 1402 621
Rotatoria alt. 2mm		IBO 1401 623	IBO 1402 623
Rotatoria alt. 3mm		IBO 1401 625	IBO 1402 625
	<b>Interfase 3G</b>		
Antirrotatoria alt. 1mm	HEC-30741	HEC-35741	HEC-43741
Antirrotatoria alt. 2mm	HEC-30743	HEC-35743	HEC-43743
Antirrotatoria alt. 3mm	HEC-30745	HEC-35745	HEC-43745
Rotatoria alt. 1mm	HEC-30740	HEC-35740	HEC-43740
Rotatoria alt. 2mm	HEC-30742	HEC-35742	HEC-43742
Rotatoria alt. 3mm	HEC-30744	HEC-35744	HEC-43744
Para minipilar R		HEC-35755	



	<b>Ø3.0</b>	<b>NP Ø3.5</b>	<b>RP Ø4.3</b>
<b>Pilar Multiunit</b>			
Alt. 1,5mm		HEC-35801	HEC-43801
Alt. 2,5mm		HEC-35802	HEC-43802
Alt. 3,5mm		HEC-35803	HEC-43803
Alt. 4,5mm		HEC-35804	HEC-43804
Alt. 5,5mm		HEC-35805	
Minipilar MultiUnit alt. 1,5mm		HEC-35811	
Minipilar MultiUnit alt. 2,5mm		HEC-35812	
Minipilar MultiUnit alt. 3,5mm		HEC-35813	
Minipilar MultiUnit alt. 4,5mm		HEC-35814	
Minipilar MultiUnit alt. 5,5mm		HEC-35815	



<b>Pilar Multiunit angulado</b>			
17° alt. 2,5mm		HEC-35852	HEC-43852
17° alt. 3,5mm		HEC-35853	HEC-43853
30° alt. 3,5mm		HEC-35863	HEC-43863
30° alt. 4,5mm		HEC-35864	HEC-43864



<b>Pilar Lock-Attach</b>			
Alt. 1mm		HEC-35901	HEC-43901
Alt. 2mm		HEC-35902	HEC-43902
Alt. 3mm		HEC-35903	HEC-43903
Alt. 4mm		HEC-35904	HEC-43904
Alt. 5mm		HEC-35905	HEC-43905
Alt. 6mm		HEC-35906	HEC-43906



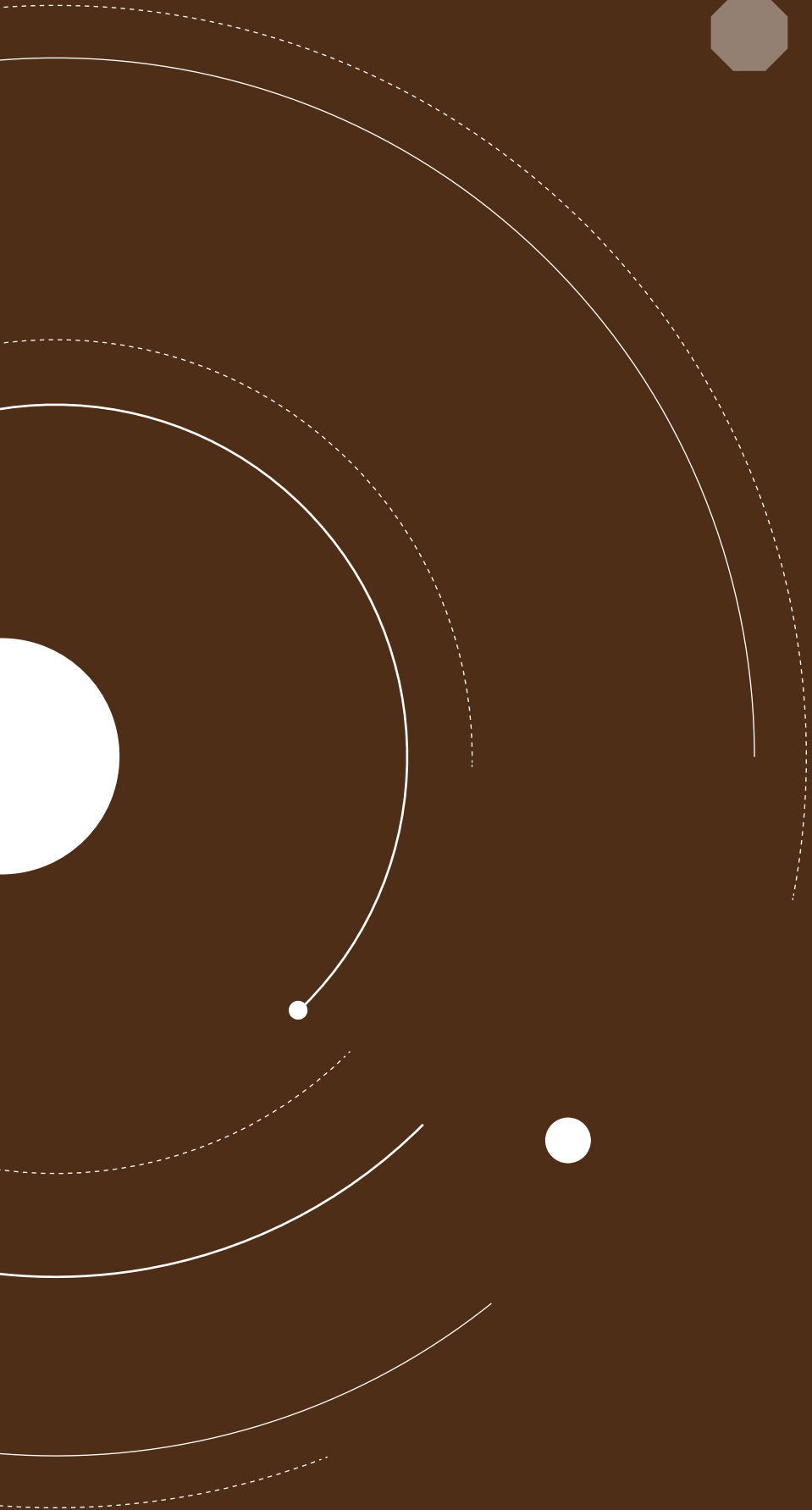
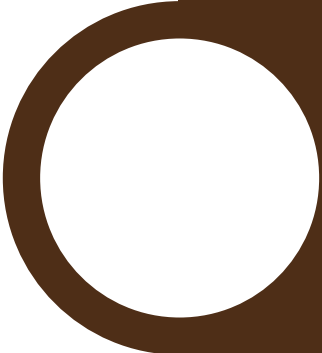



# ZIMMER®

## HEI

CAD/CAM 1500  
SCREW VENT®

---

Ibodontit S.L. no guarda relación con ninguna de las marcas aquí referenciadas, que son propiedad de sus respectivos titulares

---

ADT®  
AXUS  
DENTAL  
TECH



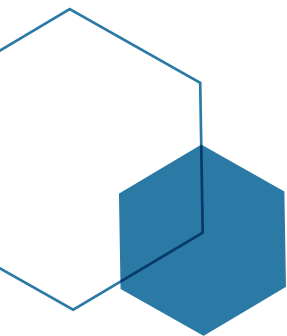















# ZIMMER® SCREW VENT®

Ø3.5 / Ø4.5 / Ø5.7



	NP Ø3.5	RP Ø4.5	WP Ø5.7
	<b>Análogo</b>		
	Ø3.5 plat 3.7 - HEI-35300 Ø3.5 plat 4.0 - HEI-35301		
		HEI-45300	HEI-57300
	<b>Tornillo análogo digital</b>		
	M1,6 hex. 1,20	HE-41215	HE-41215
		HE-41215	HE-41215
	<b>Transfer de impresión</b>		
	Cubeta abierta (CA)	HEI-35700	HEI-57700
	Cubeta cerrada (CC)	HEI-35710	
	Tornillo transfer CA	HEI-35701	
	Tornillo transfer CC	HEI-35711	
	<b>Tapón de cicatrización</b>		
	Alt. 2mm	HEI-35402	
	Alt. 3mm	HEI-35403	HEI-57403
	Alt. 4mm	HEI-35404	HEI-45404
	Alt. 5mm	HEI-35405	HEI-45405
	<b>Tornillo</b>		
	M1.8 c/hex. 1.20	HEI-35200	HEI-35200
	M1.8 c/hex. 1.27	HEI-35201	HEI-35201
	M1.8 c/hex. 1.20 DLC	HEI-35280	HEI-35280
	M1.8 Autoblocante c/hex. 1.25	HEI-35205	HEI-35205
	M1.8 Oro c/hex.1.20	HEI-35206	HEI-35206
	M1.8 Cierre	HEI-35210	
	<b>M1,8 Tetralobular ACS</b>	IBO 1501 225	IBO 1501 225
		IBO 1501 225	IBO 1501 225
	<b>Calcinable</b>		
	Antirrotatorio Ø3.5 plat 3.7	HEI-35001	
	Rotatorio Ø3.5 plat 3.7	HEI-35010	
	Antirrotatorio Ø3.5 plat 4,0	HEI-35002	
	Rotatorio Ø3.5 plat 4,0	HEI-35011	
	Antirrotatorio		HEI-57001
	Rotatorio	HEI-45010	HEI-57010

	<i>NP Ø3.5</i>	<i>RP Ø4.5</i>	<i>WP Ø5.7</i>																												
	<b>Calcinable base Cr-Co</b>																														
Antirrotatorio	HEI-35110	HEI-45110	HEI-57110																												
Rotatorio	HEI-35100	HEI-45100																													
	<b>Chimenea angulada base Cr-Co</b>																														
17°	IBO 1102 011	IBO 1102 011																													
30°	IBO 1102 012	IBO 1102 012																													
	<b>Pilar provisional</b>																														
Antirrotatorio	HEI-35600	HEI-45600																													
Rotatorio	HEI-35610	HEI-45610																													
	<b>Pilar recto / angulado</b>																														
Recto Antirrotatorio	HEI-35505																														
Ang. 15°	HEI-35650																														
Ang. 25°	HEI-35651																														
	<b>Ball Attach</b>																														
Ø1.8 alt. 2mm	HEI-35552																														
Ø1.8 alt. 4mm	HEI-35554																														
Ø2.5 Basculante alt. 2mm	109CV2R																														
Ø2.5 Basculante alt. 4mm	109CV4R																														
	<table border="0"> <tr> <td>Kit Retenciones Ø1.8</td> <td>192ACM</td> <td></td> <td></td> </tr> <tr> <td>Kit Ret. normal (1100 gr) Ø1.8 (6ud)</td> <td>040CRM</td> <td></td> <td></td> </tr> <tr> <td>Kit Ret. Suave (900 gr) Ø1.8 (6ud)</td> <td>040CRMSN</td> <td></td> <td></td> </tr> <tr> <td>Kit Retenciones para Ø 2.5</td> <td>192ACN</td> <td></td> <td></td> </tr> <tr> <td>Kit Ret normal (1300 gr) Ø2.5 (6ud)</td> <td>040CRN</td> <td></td> <td></td> </tr> <tr> <td>Kit Ret Suave (900 gr) Ø2.5 (6ud)</td> <td>040CRNSN</td> <td></td> <td></td> </tr> <tr> <td>Anillos direccionales</td> <td>100AD</td> <td></td> <td></td> </tr> </table>			Kit Retenciones Ø1.8	192ACM			Kit Ret. normal (1100 gr) Ø1.8 (6ud)	040CRM			Kit Ret. Suave (900 gr) Ø1.8 (6ud)	040CRMSN			Kit Retenciones para Ø 2.5	192ACN			Kit Ret normal (1300 gr) Ø2.5 (6ud)	040CRN			Kit Ret Suave (900 gr) Ø2.5 (6ud)	040CRNSN			Anillos direccionales	100AD		
Kit Retenciones Ø1.8	192ACM																														
Kit Ret. normal (1100 gr) Ø1.8 (6ud)	040CRM																														
Kit Ret. Suave (900 gr) Ø1.8 (6ud)	040CRMSN																														
Kit Retenciones para Ø 2.5	192ACN																														
Kit Ret normal (1300 gr) Ø2.5 (6ud)	040CRN																														
Kit Ret Suave (900 gr) Ø2.5 (6ud)	040CRNSN																														
Anillos direccionales	100AD																														
	<b>Scanbody</b>																														
Intraoral titanio	IBO 1501 702	IBO 1502 702	IBO 1503 702																												
Laboratorio Peek	HEI-35770	HEI-45770	HEI-57770																												
	<b>Interfase 1G</b>																														
Antirrotatoria	HEI-35751	HEI-45751																													
Rotatoria	HEI-35750	HEI-45750																													
	<b>Interfase AC 2G</b>																														
Antirrotatoria alt 0,5mm	IBO 1501 620	IBO 1502 620	IBO 1503 620																												
Antirrotatoria alt 1,5mm	IBO 1501 622	IBO 1502 622																													
Antirrotatoria alt 2,5mm	IBO 1501 624																														
Rotatoria alt 0,5mm	IBO 1501 621	IBO 1502 621	IBO 1503 621																												
Rotatoria alt 1,5mm	IBO 1501 623	IBO 1502 623																													
Rotatoria alt 2,5mm	IBO 1501 625																														



**NP Ø3.5**

**RP Ø4.5**

**WP Ø5.7**

**Interfase 3G**

Antirrotatoria alt 0,5mm	HEI-35741	HEI-45741	
Antirrotatoria alt 1,5mm	HEI-35743	HEI-45743	
Antirrotatoria alt 2,5mm	HEI-35745		
Rotatoria alt 0,5mm	HEI-35740	HEI-45740	
Rotatoria alt 1,5mm	HEI-35742	HEI-45742	
Rotatoria alt 2,5mm	HEI-35744		



**Pilar Multiunit**

Alt. 1mm	HEI-35801	HEI-45801	
Alt. 2mm	HEI-35802	HEI-45802	
Alt. 3mm	HEI-35803	HEI-45803	
Alt. 4mm	HEI-35804	HEI-45804	
Alt. 5mm	HEI-35805	HEI-45805	



**Pilar Multiunit angulado**

17° alt. 2mm	HEI-35852	HEI-45852	
17° alt. 3mm	HEI-35853	HEI-45853	
17° alt. 4mm	HEI-35854	HEI-45854	
30° alt. 4mm	HEI-35864	HEI-45864	
30° alt. 5mm	HEI-35865	HEI-45865	
30° alt. 6mm	HEI-35866	HEI-45866	



**Pilar Lock-Attach**

Alt. 1mm	HEI-35901	HEI-45901	HEI-57901
Alt. 2mm	HEI-35902	HEI-45902	HEI-57902
Alt. 3mm	HEI-35903	HEI-45903	HEI-57903
Alt. 4mm	HEI-35904	HEI-45904	HEI-57904
Alt. 5mm	HEI-35905	HEI-45905	HEI-57905
Alt. 6mm	HEI-35906	HEI-45906	
 Angulado alt. 1,5mm	HEI-35951		
Angulado alt. 3mm	HEI-35953		

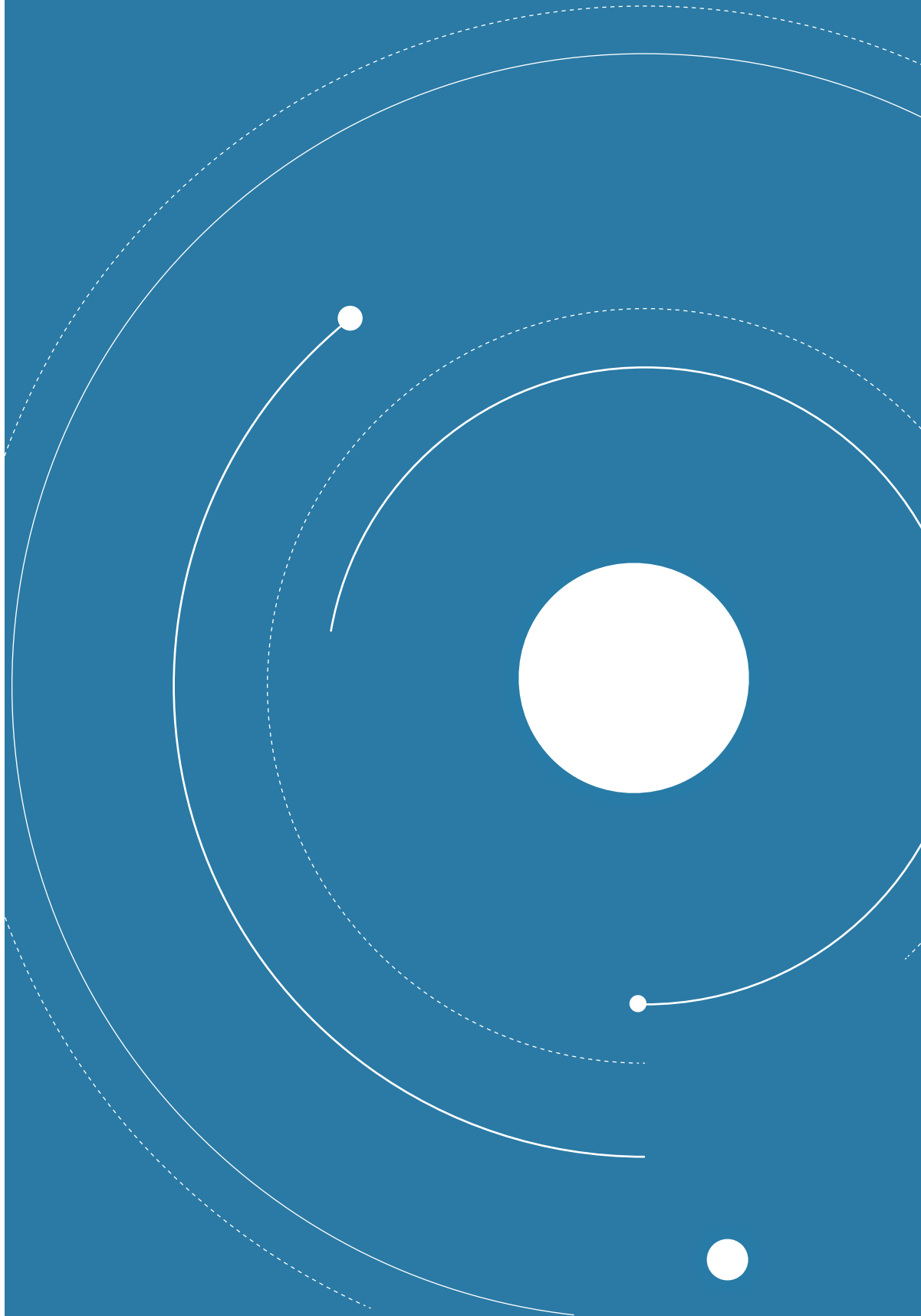





# STRAUMANN®

**HI** CAD/CAM 1800  
TISSUE LEVEL®

**HI** CAD/CAM 1900  
BONE LEVEL®

CAD/CAM 3800  
BLX®

---

Ibodontit S.L. no guarda relación con ninguna de las marcas aquí referenciadas, que son propiedad de sus respectivos titulares

---

**ADT**®  
AXUS  
DENTAL  
TECH



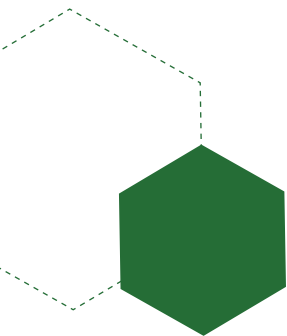







# STRAUMANN®

## TISSUE LEVEL®

RN Ø4.8 / WN Ø6.5



	<b>RN Ø4.8</b>	<b>WN Ø6.5</b>
	<b>Análogo</b>	
Directo a implante	HI-48300	HI-65300
Synocta	HI-48301	
	<b>Tornillo análogo digital</b>	
M1,6 hex. 1,20	HE-41215	HE-41215
	<b>Transfer de impresión</b>	
Cubeta abierta (CA)	HI-48700	HI-65700
Impresión directa pilar Synocta cementable	HI-48704	
	<b>Tapón de cicatrización</b>	
Alt. 2mm	HI-48402	
Alt. 3mm	HI-48403	
Alt. 4.5mm	HI-48404	
	<b>Tornillo</b>	
M2 Torx para calcinable directo implante	HI-48200	
M2 Torx	HI-48204	HI-48204
M2 Torx DLC	HI-48280	HI-48280
M2 Autoblocante Torx	HI-48205	
M2 Oro Torx	HI-48206	HI-48206
M2 Torx para Synocta	HI-48201	
M2 Cierre	HI-48210	
M2 Cierre especial (alt. 1.5mm)	HI-48211	
<b>M2 Tetralobular ACS</b>	IBO 1801 225	IBO 1801 225
<b>M2 Tetralobular ACS para Synocta</b>	IBO 1801 226	IBO 1801 226
	<b>Calcinable</b>	
Antirrotatorio directo implante	HI-48001	HI-65001
Rotatorio directo a implante	HI-48010	HI-65010
Antirrotatorio para Synocta	HI-48002	
Rotatorio para Synocta	HI-48011	
Antirrotatorio para Synocta cementar	HI-48003	
Rotatorio para Synocta cementar	HI-48012	

**RN Ø4.8**

**WN Ø6.5**



**Calcinable Base Cr-Co**

Antirrotatorio directo a implante	HI-48110	HI-65110
Rotatorio directo a implante	HI-48100	HI-65100
Antirrotatorio para Synocta	HI-48111	
Rotatorio para Synocta	HI-48101	



**Chimenea angulada base Cr-Co**

17° directo a implante	IBO 1102 013
30° directo a implante	IBO 1102 014
17° para Synocta	IBO 1102 011
30° para Synocta	IBO 1102 012



**Pilar provisional**

Antirrotatorio directo a implante	HI-48600	HI-65600
Rotatorio directo a implante	HI-48611	HI-65610
Antirrotatorio para Synocta	HI-48615	
Rotatorio para Synocta	HI-48610	



**Pilar recto / Synocta**

Antirrotatorio alt. 4mm para cementar	HI-48504
Antirrotatorio alt. 5mm para cementar	HI-48505
Antirrotatorio alt. 7mm para cementar	HI-48507
Pilar Synocta	HI-48530
Pilar Octa	HI-48535
Pilar Synocta para cementar	HI-48531



**Ball Attach**

Ø2.5 Basculante alt. 2mm	109BFT2R
Ø2.5 Basculante alt. 4mm	109BFT4R



Kit Retenciones para Ø 2.5	192ACN
Kit Ret Normal (1300 gr) Ø2.5 (6ud)	040CRN
Kit Ret Suave (900 gr) Ø2.5 (6ud)	040CRNSN
Anillos Direccionales	100AD



**Scanbody**

Intraoral titanio directo a implante	IBO 1801 703	IBO 1802 702
Laboratorio Peek directo a implante	HI-48770	HI-65770
Intraoral titanio para Synocta	IBO 1801 704	
Laboratorio Peek para Synocta	HI-48771	



**Interfase 1G**

Antirrotatoria directo a implante	HI-48751
Rotatoria directo a implante	HI-48750

**RN Ø4.8**

**WN Ø6.5**



**Interfase AC 2G**

Antirrotatoria directo a implante	IBO 1801 620	IBO 1802 620
Rotatoria directo a implante	IBO 1801 621	IBO 1802 621
Antirrotatoria para Synocta	IBO 1801 622	
Rotatoria para Synocta	IBO 1801 623	



**Interfase 3G**

Antirrotatoria alt 0,9 directo a implante	HI-48741
Antirrotatoria alt 2 directo a implante	HI-48743
Rotatoria alt 0,9 directo a implante	HI-48740
Rotatoria alt 2 directo a implante	HI-48742



**Pilar Multiunit**

Alt. 0,9mm	HI-48801
------------	----------



**Pilar Multiunit angulado**

17° alt. 2,5 mm	HI-48852
30° alt. 3.5mm	HI-48863



**Pilar Lock-Attach**

Alt. 1mm	HI-48901
Alt. 2mm	HI-48902
Alt. 3mm	HI-48903
Alt. 4mm	HI-48904
Alt. 5mm	HI-48905
Alt. 6mm	HI-48906
 Angulado alt. 1,5mm	HI-48951
Angulado alt. 3mm	HI-48953

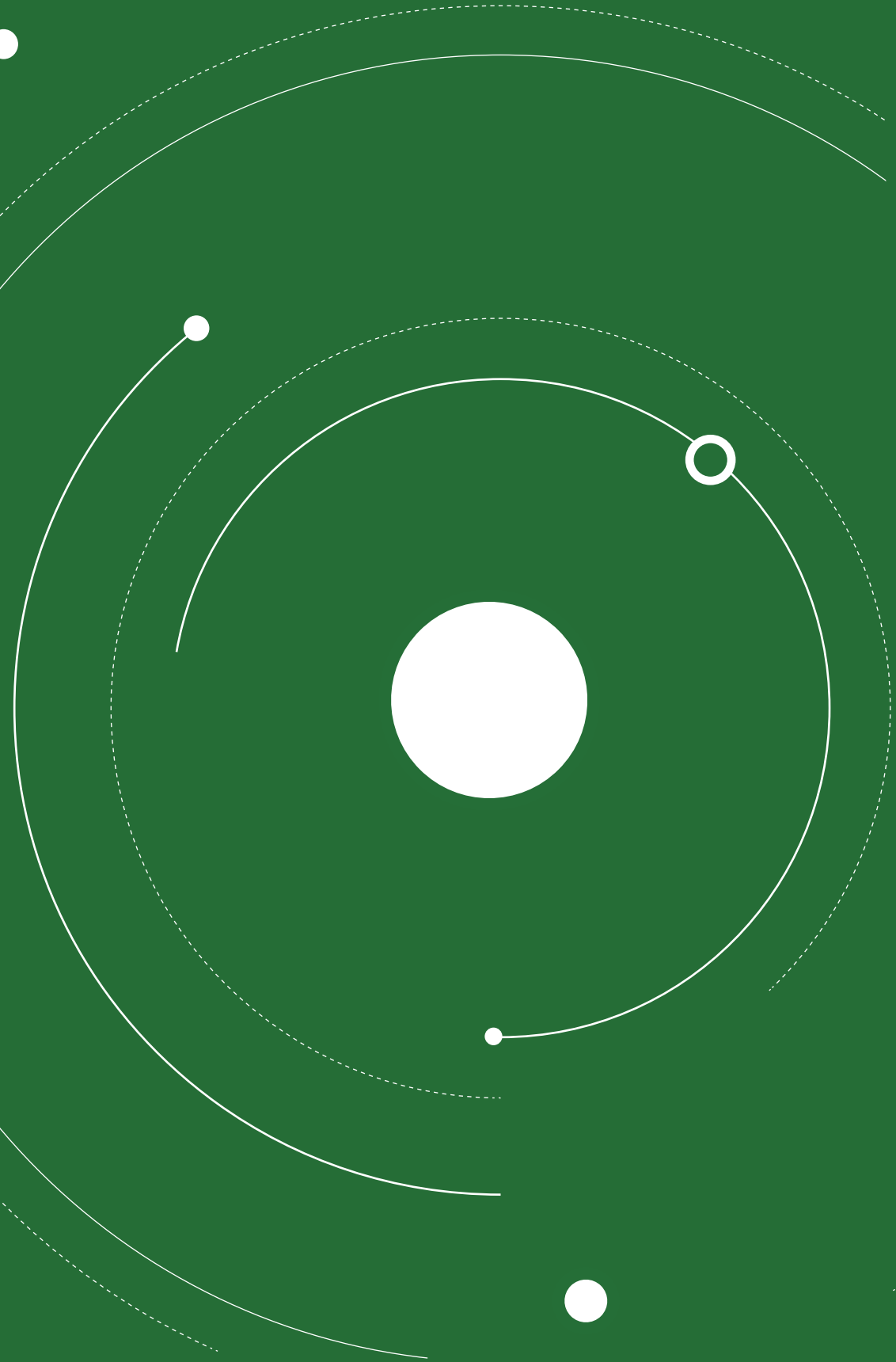

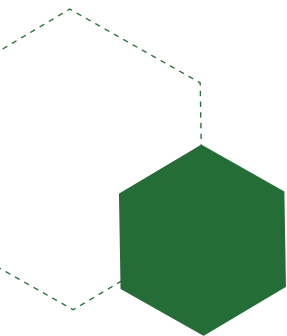





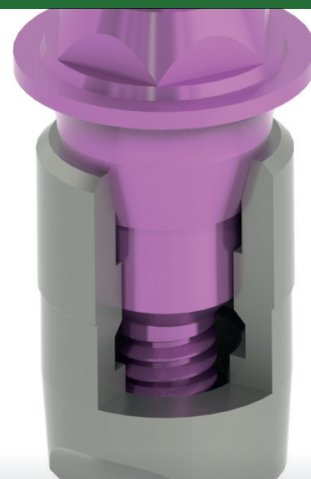



# STRAUMANN® BONE LEVEL®

NC Ø3.3 / RC Ø4.1



	NC Ø3.3	RC Ø4.1
	<b>Análogo</b>	
	HI-33300	HI-41300
	<b>Tornillo análogo digital</b>	
M1,6 hex. 1,20	HE-41215	HE-41215
	<b>Transfer de impresión</b>	
Cubeta abierta (CA)	HI-33700	HI-41700
	<b>Tapón de cicatrización</b>	
Alt. 2mm	HI-33402	HI-41402
Alt. 4mm	HI-33404	HI-41404
Alt. 5mm	HI-33405	
Alt. 6mm		HI-41406
	<b>Tornillo</b>	
M1,6 Torx	HI-33200	HI-41200
M1,6 Torx de oro	HI-33206	HI-41206
M1,6 Torx DLC	HI-33280	HI-41280
<b>M1,8 Tetralobular ACS</b>	IBO 1902 225	IBO 1902 225
	<b>Calcinable</b>	
Antirrotatorio	HI-33001	HI-41001
Rotatorio	HI-33010	HI-41010
	<b>Calcinable Base Cr-Co</b>	
Antirrotatorio	HI-33110	HI-41110
Rotatorio	HI-33100	HI-41100
	<b>Chimenea angulada base Cr-Co</b>	
17°	IBO 1102 011	IBO 1102 011
25°	IBO 1102 015	IBO 1102 015

**NC Ø3.3**

**RC Ø4.1**



**Pilar provisional**

Antirrotatorio	HI-33600	HI-41600
Rotatorio	HI-33610	HI-41610



**Pilar recto**

Antirrotatorio		HI-41501
Rotatorio		HI-41550



**Scanbody**

Intraoral titanio	IBO 1901 702	IBO 1902 702
Laboratorio Peek	HI-33770	HI-41770



**Interfase AC 2G**

Antirrotatoria alt.1mm	IBO 1901 620	IBO 1902 620
Antirrotatoria alt.2mm	IBO 1901 622	IBO 1902 622
Antirrotatoria alt.3mm	IBO 1901 624	IBO 1902 624
Rotatoria alt. 1mm	IBO 1901 621	IBO 1902 621
Rotatoria alt. 2mm	IBO 1901 623	IBO 1902 623
Rotatoria alt. 3mm	IBO 1901 625	IBO 1902 625



**Interfase 3G**

Antirrotatoria alt.1mm	HI-33741	HI-41741
Antirrotatoria alt.2mm	HI-33743	HI-41743
Antirrotatoria alt.3mm	HI-33745	HI-41745
Rotatoria alt. 1mm	HI-33740	HI-41740
Rotatoria alt. 2mm	HI-33742	HI-41742
Rotatoria alt. 3mm	HI-33744	HI-41744



**Pilar Multiunit**

Alt. 1,5mm	HI-33801	HI-41801
Alt. 2,5mm	HI-33802	HI-41802
Alt. 3,5mm	HI-33803	HI-41803
Alt. 4,5mm	HI-33804	HI-41804



**Pilar Multiunit angulado**

17° alt. 2,5mm	HI-33852	HI-41852
17° alt. 3,5mm	HI-33853	HI-41853
30° alt. 3,5mm	HI-33863	HI-41863
30° alt. 4,5mm	HI-33864	HI-41864



**Pilar Lock-Attach**

Alt. 1mm	HI-33901	HI-41901
Alt. 2mm	HI-33902	HI-41902
Alt. 3mm	HI-33903	HI-41903
Alt. 4mm	HI-33904	HI-41904
Alt. 5mm	HI-33905	HI-41905
Alt. 6mm	HI-33906	HI-41906

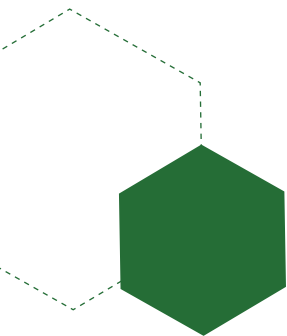

# STRAUMANN® BLX®

RB / WB

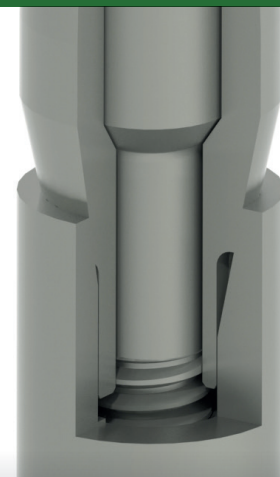

**RB / WB**



## Análogo

IBO 3801 300



## Tornillo análogo digital

M1,6 hex. 1,20

HE-41215



## Transfer de impresión

Cubeta abierta (CA)

IBO 3801 350



## Tapón de cicatrización

Alt. 2mm  
Alt. 4mm  
Alt. 6mm

IBO 3801 402  
IBO 3801 404  
IBO 3801 406



## Tornillo

M1.6 Torx

IBO 3801 200

M1,6 Tetralobular ACS

IBO 3801 225



## Calcinable base Cr-Co

Antirrotatorio  
Rotatorio

IBO 3801 110  
IBO 3801 100



## Pilar provisional

Antirrotatorio  
Rotatorio

IBO 3801 550  
IBO 3801 555



## Scanbody

Intraoral titanio

IBO 3801 702



RB / WB



### Interfase AC 2G

Antirrotatoria	IBO 3801 620
Rotatoria	IBO 3801 621



### Interfase 3G

Antirrotatoria alt. 1mm	IBO 3801 601
Antirrotatoria alt. 2mm	IBO 3801 603
Antirrotatoria alt. 3mm	IBO 3801 605
Rotatoria alt. 1mm	IBO 3801 600
Rotatoria alt. 2mm	IBO 3801 602
Rotatoria alt. 3mm	IBO 3801 604



### Pilar Multiunit

Alt. 1,5mm	IBO 3801 801
Alt. 2,5mm	IBO 3801 802
Alt. 3,5mm	IBO 3801 803
Alt. 4,5mm	IBO 3801 804



### Pilar Multiunit angulado

17° alt. 2,5mm	IBO 3801 852
17° alt. 3,5mm	IBO 3801 853
30° alt. 3,5mm	IBO 3801 863
30° alt. 4,5mm	IBO 3801 864



### Pilar Lock-Attach

Alt. 1mm	IBO 3801 901
Alt. 2mm	IBO 3801 902
Alt. 3mm	IBO 3801 903
Alt. 4mm	IBO 3801 904
Alt. 5mm	IBO 3801 905



# ASTRA TECH®

**HEA**

**CAD/CAM 2000  
OSSEOSPEED Tx®**

**CAD/CAM 3200  
EV®**

---

Ibodontit S.L. no guarda relación con ninguna de las marcas aquí referenciadas, que son propiedad de sus respectivos titulares

---

**ADT**®  
AXUS  
DENTAL  
TECH



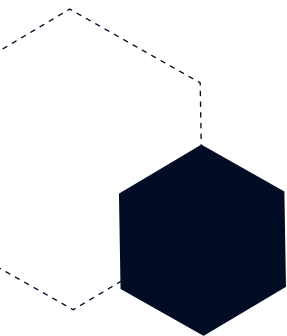







# ASTRA TECH<sup>®</sup> OSSEOSPEED TX<sup>®</sup>

Ø3.0 / AQUA Ø3.5 - Ø4.0 / LILAC Ø4.5 - Ø5.0



	Ø3.0	AQUA Ø3.5 - 4.0	LILAC Ø4.5 - 5.0
	<b>Análogo</b>		
	IBO 2003 300	HEA-35300	HEA-45300
		HEA-35310	
	<b>Tornillo análogo digital</b>		
M1,6 hex. 1,20	HE-41215	HE-41215	HE-41215
	<b>Análogo 20°</b>		
		HEA-35301	
	<b>Transfer de impresión</b>		
Cubeta abierta (CA) Cubeta cerrada (CC)	IBO 2003 350	HEA-35700 HEA-35710	HEA-45700
	<b>Tapón de cicatrización</b>		
Alt. 2mm	IBO 2003 402	HEA-35402	HEA-45402
Alt. 4mm	IBO 2003 404	HEA-35404	HEA-45404
Alt. 5mm		HEA-35406	HEA-45406
	<b>Tornillo</b>		
M1,4 hex. 1.27	IBO 2003 200		
M1,6 hex. 1.27		HEA-35200	
20° M1,6 hex. 1.27		HEA-35201	
M1,6 hex. 1.27 DLC		HEA-35280	
M2 hex. 1.27			HEA-45200
<b>M1,6 Tetralobular ACS</b> <b>M2 Tetralobular ACS</b>		IBO 2001 225	IBO 1302 225
	<b>Calcinable</b>		
Antirrotatorio		HEA-35001	HEA-45001
Rotatorio		HEA-35010	HEA-45010
20°		HEA-35011	



**Calcinable base Cr-Co**

	Ø3.0	AQUA Ø3.5 - 4.0	LILAC Ø4.5 - 5.0
Antirrotatorio	IBO 2003 110	HEA-35110	HEA-45110
Rotatorio		HEA-35100	HEA-45100



**Chimenea angulada base Cr-Co**

17°		IBO 1102 011	
30°		IBO 1102 012	



**Pilar provisional**

Antirrotatorio		HEA-35600	HEA-45600
Rotatorio		HEA-35610	HEA-45610



**Pilar recto**

Antirrotatorio		HEA-35500	HEA-45500
Rotatorio		HEA-35550	HEA-45550



**Pilar 20°**

Alt. 0,5mm		HEA-35551	HEA-45551
Alt. 1mm		HEA-35552	HEA-45552
Alt. 2mm		HEA-35553	HEA-45553
Alt. 4mm		HEA-35554	HEA-45554



**Scanbody**

Intraoral titanio	IBO 2003 702	IBO 2001 702	IBO 2002 702
Laboratorio Peek		HEA-35770	HEA-45770



**Interfase 1G**

Antirrotatoria		HEA-35751	
Rotatoria		HEA-35750	



**Interfase AC 2G**

Antirrotatoria alt. 1mm	IBO 2003 620	IBO 2001 620	IBO 2002 620
Antirrotatoria alt. 2mm		IBO 2001 622	
Antirrotatoria alt. 3mm		IBO 2001 624	
Rotatoria alt. 1mm		IBO 2001 621	IBO 2002 621
Rotatoria alt. 2mm		IBO 2001 623	
Rotatoria alt. 3mm		IBO 2001 625	



**Interfase 3G**

20°		HEA-35780	
Antirrotatoria alt. 1mm		HEA-35741	HEA-45741
Antirrotatoria alt. 2mm		HEA-35743	HEA-45743
Antirrotatoria alt. 3mm		HEA-35745	
Rotatoria alt. 1mm		HEA-35740	HEA-45740
Rotatoria alt. 2mm		HEA-35742	HEA-45742
Rotatoria alt. 3mm		HEA-35744	



**Pilar Multiunit**

	<i>Ø3.0</i>	<i>AQUA Ø3.5 - 4.0</i>	<i>LILAC Ø4.5 - 5.0</i>
Alt. 0,5mm		HEA-35800	
Alt. 1,5mm		HEA-35801	HEA-45801
Alt. 2,5mm		HEA-35802	HEA-45802
Alt. 3,5mm		HEA-35803	HEA-45803
Alt. 4,5mm		HEA-35804	HEA-45804



**Pilar Multiunit angulado**

17° alt. 2,5mm		HEA-35852	HEA-45852
17° alt. 3,5mm		HEA-35853	HEA-45853
30° alt. 3,5mm		HEA-35863	HEA-45863
30° alt. 4,5mm		HEA-35864	HEA-45864



**Pilar Lock-Attach**

Alt. 0,5mm			HEA-45901
Alt. 1mm		HEA-35901	
Alt. 2mm		HEA-35902	HEA-45902
Alt. 3mm		HEA-35903	HEA-45903
Alt. 4mm		HEA-35904	HEA-45904
Alt. 5mm		HEA-35905	HEA-45905

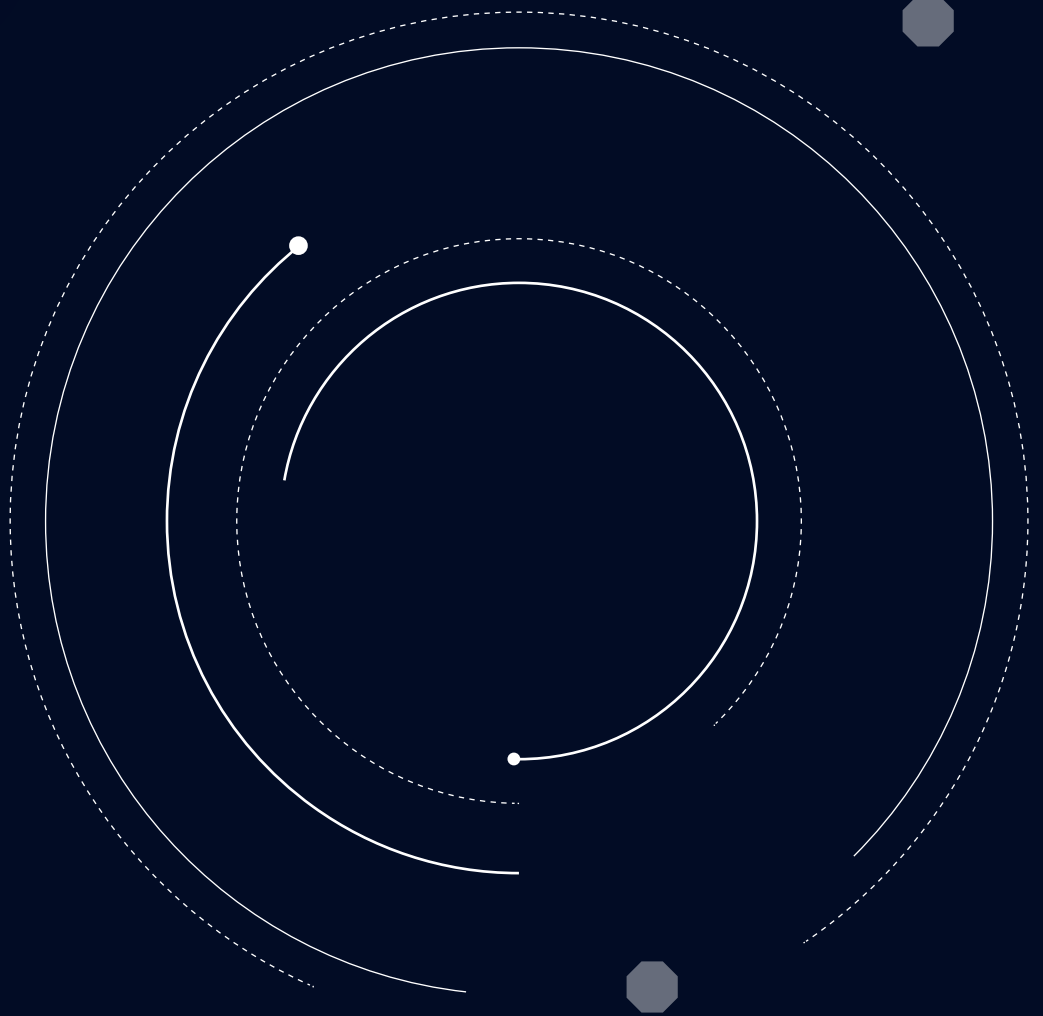
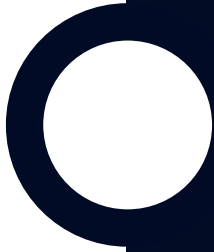

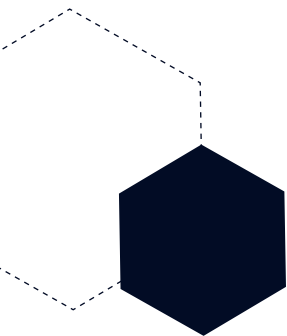





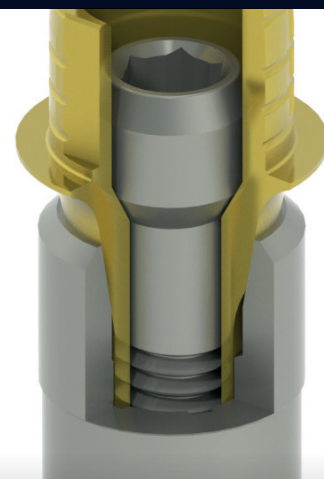











# ASTRA TECH<sup>®</sup> EV<sup>®</sup>

Ø3.0 / Ø3.6 / Ø4.2 / Ø4.8



	Ø3.0	Ø3.6	Ø4.2	Ø4.8
	<b>Análogo</b>			
	IBO 3201 300	IBO 3202 300	IBO 3203 300	IBO 3204 300
	<b>Tornillo análogo digital</b>			
M1,6 hex. 1,20	HE-41215	HE-41215	HE-41215	HE-41215
	<b>Análogo 33°</b>			
		IBO 3203 301	IBO 3203 301	IBO 3203 301
	<b>Transfer de impresión</b>			
Cubeta abierta (CA)		IBO 3202 350	IBO 3203 350	IBO 3204 350
	<b>Tapón de cicatrización</b>			
Alt. 2mm	IBO 3201 402	IBO 3202 402	IBO 3203 402	IBO 3204 402
Alt. 4mm	IBO 3201 404	IBO 3202 404	IBO 3203 404	IBO 3204 404
	<b>Tornillo</b>			
M1,4 hex. 1.27	IBO 3201 200			
M1,6 hex. 1.27		IBO 3202 200		
M1,8 hex. 1.27			IBO 3203 200	
M2 hex. 1.27				IBO 3204 200
<b>M1,6 Tetralobular ACS</b>		IBO 3202 225		
<b>M1,8 Tetralobular ACS</b>			IBO 3203 225	
<b>M2 Tetralobular ACS</b>				IBO 3204 225
	<b>Calcinable</b>			
Antirrotatorio	IBO 3201 001	IBO 3202 001	IBO 3203 001	IBO 3204 001
Rotatorio		IBO 3202 010	IBO 3203 010	IBO 3204 010



	Ø3.0	Ø3.6	Ø4.2	Ø4.8
	<b>Calcineable base Cr-Co</b>			
Antirrotatorio	IBO 3201 110	IBO 3202 110	IBO 3203 110	IBO 3204 110
Rotatorio		IBO 3202 100	IBO 3203 100	IBO 3204 100
	<b>Chimenea angulada base Cr-Co</b>			
17°		IBO 1102 011	IBO 1102 011	IBO 1102 013
30°		IBO 1102 012	IBO 1102 012	IBO 1102 014
	<b>Pilar provisional</b>			
Antirrotatorio	IBO 3201 550	IBO 3202 550	IBO 3203 550	IBO 3204 550
Rotatorio	IBO 3201 555	IBO 3202 555	IBO 3203 555	IBO 3204 555
	<b>Scanbody</b>			
Intraoral titanio	IBO 3201 702	IBO 3202 702	IBO 3203 702	IBO 3204 702
Laboratorio Peek	IBO 3201 700	IBO 3202 700	IBO 3203 700	IBO 3204 700
	<b>Interfase 2G</b>			
Antirrotatoria alt 1mm	IBO 3201 620	IBO 3202 620	IBO 3203 620	IBO 3204 620
Rotatoria alt 1mm		IBO 3202 621	IBO 3203 621	IBO 3204 621
	<b>Interfase 3G</b>			
Antirrotatoria alt 1mm		IBO 3202 601	IBO 3203 601	
Antirrotatoria alt 2mm		IBO 3202 603	IBO 3203 603	
Rotatoria alt 1mm		IBO 3202 600	IBO 3203 600	
Rotatoria alt 2mm		IBO 3202 602	IBO 3203 602	
	<b>Pilar Multiunit</b>			
Alt. 1,5mm		IBO 3202 801	IBO 3203 801	IBO 3204 801
Alt. 2,5mm		IBO 3202 802	IBO 3203 802	IBO 3204 802
Alt. 3,5mm		IBO 3202 803	IBO 3203 803	IBO 3204 803
Alt. 4,5mm		IBO 3202 804	IBO 3203 804	IBO 3204 804
	<b>Pilar Multiunit angulado</b>			
17° alt. 2,5mm		IBO 3202 852	IBO 3203 852	IBO 3204 852
17° alt. 3,5mm		IBO 3202 853	IBO 3203 853	IBO 3204 853
30° alt. 3,5mm		IBO 3202 864	IBO 3203 864	IBO 3204 864
30° alt. 4,5mm		IBO 3202 865	IBO 3203 865	IBO 3204 865
	<b>Pilar Lock-Attach</b>			
Alt. 1mm		IBO 3202 901	IBO 3203 901	IBO 3204 901
Alt. 2mm		IBO 3202 902	IBO 3203 902	IBO 3204 902
Alt. 3mm		IBO 3202 903	IBO 3203 903	IBO 3204 903
Alt. 4mm		IBO 3202 904	IBO 3203 904	IBO 3204 904



# BIOMET 3i®

**HE** CAD/CAM 2100  
HEX.EXTERNO®

**HEW** CAD/CAM 2200  
CERTAIN®

---

Ibodontit S.L. no guarda relación con ninguna de las marcas aquí referenciadas, que son propiedad de sus respectivos titulares

---

**ADT**®  
AXUS  
DENTAL  
TECH



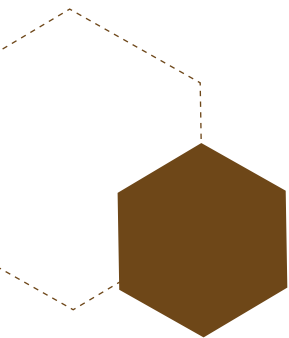





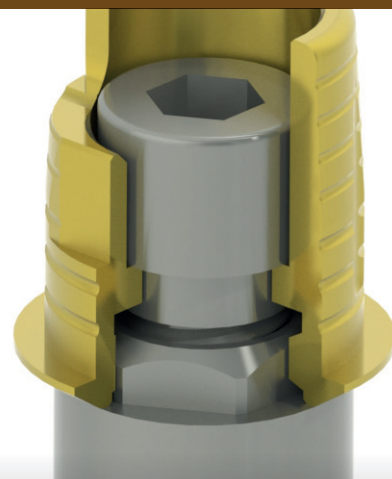

# BIOMET 3i<sup>®</sup> HEX.EXTERNO<sup>®</sup>

Ø3.25 / Ø4.1 / Ø5.0



	<i>NP Ø3.25</i>	<i>RP Ø4.1</i>	<i>WP Ø5.0</i>
	<b>Análogo</b>		
	IBO 2101 300	HE-41300	HE-51300
	<b>Tornillo análogo digital</b>		
M1,6 hex. 1,20	HE-41215	HE-41215	HE-41215
	<b>Transfer de impresión</b>		
Cubeta abierta (CA)		HE-41700	HE-51700
Tornillo transfer CA		HE-41701	
Cubeta cerrada (CC)		HE-41710	
Tornillo transfer CC		HE-41711	
	<b>Tapón de cicatrización</b>		
Alt. 2mm		HE-41402	
Alt. 3mm		HE-41403	HE-51403
Alt. 4mm		HE-41404	
Alt. 5mm		HE-41405	HE-51405
	<b>Tornillo</b>		
M2 hex. 1,20	IBO 2101 200	HE-41200	HE-41200
M2 hex. 1,20 DLC		HE-41280	HE-41280
M2 hex. 1.20 as. plano		HE-41201	HE-41201
M2 cuadrada 1.30		HE-41202	HE-41202
M2 hex. 1.25		HE-41203	HE-41203
M2 hex. 1.20 plana		HE-41204	HE-41204
M2 Autoblocante c/hex. 1.25		HE-41205	HE-41205
M2 Tornillo oro c/hex.1.20		HE-41206	HE-41206
M2 Unigrip		HE-41207	HE-41207
M2 hex. 1.20 (rosca total)		HE-41208	HE-41208
M2 Cierre		HE-41210	
<b>M2 Tetralobular ACS</b>		IBO 1102 225	
	<b>Calcinable</b>		
Antirrotatorio	IBO 2101 001	HE-41001	HE-51001
Rotatorio	IBO 2101 010	HE-41010	HE-51010

NP Ø3.25

RP Ø4.1

WP Ø5.0



**Calcinable base Cr-Co**

Antirrotatorio	IBO 2101 110	HE-41110	HE-51111
Rotatorio	IBO 2101 100	HE-41100	HE-51101



**Chimenea angulada base Cr-Co**

17°	IBO 1102 011
30°	IBO 1102 012



**Pilar provisional**

Antirrotatorio	HE-41600	HE-51600
Rotatorio	HE-41610	HE-51610



**Pilar recto**

Antirrotatorio	HE-41500
Rotatorio	HE-41550



**Pilar angulado**

15°	HE-41650
25°	HE-41651



**Scanbody**

Intraoral titanio	IBO 2101 702	IBO 1102 702	IBO 2103 702
Laboratorio Peek	IBO 2101 700	HE-41770	HE-51770



**Interfase 1G**

Antirrotatoria	HE-41751
Rotatoria	HE-41750



**Interfase AC 2G**

Antirrotatoria alt. 0,5mm	IBO 2101 620	IBO 1102 620	IBO 2103 620
Antirrotatoria alt. 1,5mm		IBO 1102 622	
Antirrotatoria alt. 2,5mm		IBO 1102 624	
Rotatoria alt. 0,5mm	IBO 2101 621	IBO 1102 621	IBO 2103 621
Rotatoria alt. 1,5mm		IBO 1102 623	
Rotatoria alt. 2,5mm		IBO 1102 625	



**Interfase 3G**

Antirrotatoria alt. 0,5mm	HE-41741
Antirrotatoria alt. 1,5mm	HE-41743
Antirrotatoria alt. 2,5mm	HE-41745
Rotatoria alt. 0,5mm	HE-41740
Rotatoria alt. 1,5mm	HE-41742
Rotatoria alt. 2,5mm	HE-41744

NP Ø3.25

RP Ø4.1

WP Ø5.0



**Pilar Multiunit**

Alt. 1mm	HE-48801
Alt. 2mm	HE-48802
Alt. 3mm	HE-48803
Alt. 4mm	HE-48804
Alt. 5mm	HE-48805
Alt. 7mm con tornillo	HE-48807



**Pilar Multiunit angulado**

17° alt. 2mm	HE-48852
17° alt. 3mm	HE-48853
17° alt. 4mm	HE-48854
30° alt. 3mm	HE-48863
30° alt. 4mm	HE-48864
30° alt. 5mm	HE-48865



**Pilar Lock-Attach**

Alt. 0,73mm	HE-41901
Alt. 2mm	HE-41902
Alt. 3mm	HE-41903
Alt. 4mm	HE-41904
Alt. 5mm	HE-41905
Alt. 6mm	HE-41906

 Angulado alt.	HE-41951
n	HE-41953



# BIOMET 3i<sup>®</sup> CERTAIN<sup>®</sup>

Ø3.4 / Ø4.1 / Ø5.0

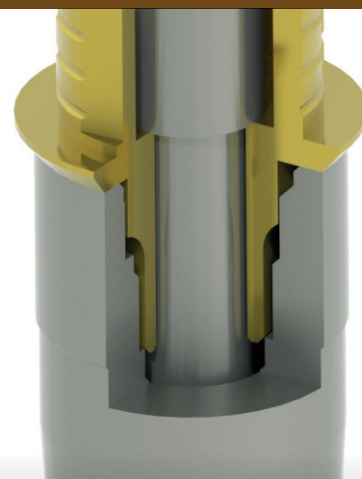

## Análogo

**NP Ø3.4**

**RP Ø4.1**

**WP Ø5.0**

HEW-34300

HEW-41300

HEW-50300



## Tornillo análogo digital

M1,6 hex 1,20

HE-41215

HE-41215

HE-41215



## Transfer de impresión

Cubeta abierta (CA)

HEW-34700

HEW-41700

HEW-50700



## Tapón de cicatrización

Alt. 3mm  
Alt. 4mm  
Alt. 6mm

HEW-34403  
HEW-34404  
HEW-34406

HEW-41403  
HEW-41404  
HEW-41406



## Tornillo

M1,6 Hex 1,2 para antirrot.  
M1,6 Hex 1,2 para antirrot. DLC  
M1,6 Cuadrado 1,3  
M1,6 Oro para antirrot.  
M1,6 Hex 1,2 para rotatorio  
M1,6 Oro para rot.  
M1,6 para rot. DLC

HEW-34200  
HEW-34280  
HEW-34201  
HEW-34206

HEW-34200  
HEW-34280  
HEW-34201  
HEW-34206  
HEW-41201  
HEW-41206  
HEW-41280

HEW-34200  
HEW-34280  
HEW-34201  
HEW-34206  
HEW-41201  
HEW-41206  
HEW-41280

**M1,6 Tetralobular ACS M6**

IBO 2201 225

IBO 2201 225

IBO 2201 225



## Calcinable

Antirrotatorio  
Rotatorio

HEW-34001  
HEW-34010

HEW-41001  
HEW-41010

HEW-50001  
HEW-50010



## Calcinable base Cr-Co

Antirrotatorio  
Rotatorio

HEW-34110  
HEW-34100

HEW-41110  
HEW-41100

HEW-50110  
HEW-50100



## Chimenea angulada base Cr-Co

17°  
30°

IBO 1102 013  
IBO 1102 014

IBO 1102 013  
IBO 1102 014

IBO 1102 011  
IBO 1102 012



	<i>NP Ø3.4</i>	<i>RP Ø4.1</i>	<i>WP Ø5.0</i>
	<b>Pilar provisional</b>		
Antirrotatorio	HEW-34600	HEW-41600	HEW-50600
Rotatorio	HEW-34610	HEW-41610	HEW-50610
	<b>Pilar recto</b>		
Antirrotatorio	HEW-34500	HEW-41500	
	<b>Scanbody</b>		
Intraoral titanio	IBO 2201 702	IBO 2202 702	IBO 2203 702
Laboratorio Peek	HEW-34770	HEW-41770	HEW-50770
	<b>Interfase AC 2G</b>		
Antirrotatorio	IBO 2201 620	IBO 2202 620	IBO 2203 620
Rotatorio	IBO 2201 621	IBO 2202 621	IBO 2203 621
	<b>Interfase 3G</b>		
Antirrotatoria alt 0,5	HEW-34741	HEW-41741	
Antirrotatoria alt 1,5	HEW-34743	HEW-41743	
Rotatoria alt 0,5	HEW-34740	HEW-41740	
Rotatoria alt 1,5	HEW-34742	HEW-41742	
	<b>Pilar Multiunit</b>		
Alt. 1mm	HEW-34801	HEW-41801	HEW-50801
Alt. 2mm	HEW-34802	HEW-41802	HEW-50802
Alt. 3mm	HEW-34803	HEW-41803	HEW-50803
Alt. 4mm	HEW-34804	HEW-41804	HEW-50804
	<b>Pilar Multiunit angulado</b>		
17° alt. 2mm	HEW-34852	HEW-41852	HEW-50852
17° alt. 4mm	HEW-34854	HEW-41854	HEW-50854
30° alt. 3mm	HEW-34863	HEW-41863	HEW-50863
30° alt. 5mm	HEW-34865	HEW-41865	HEW-50865
	<b>Pilar Lock-Attach</b>		
Alt. 1mm	HEW-34901	HEW-41901	
Alt. 2mm	HEW-34902	HEW-41902	
Alt. 3mm	HEW-34903	HEW-41903	
Alt. 4mm	HEW-34904	HEW-41904	
Alt. 5mm	HEW-34905	HEW-41905	
Alt. 6mm	HEW-34906	HEW-41906	



# MIS<sup>®</sup>

**HEM** CAD/CAM 1700  
SEVEN<sup>®</sup>

CAD/CAM 4000  
C1/V3<sup>®</sup>

---

Ibodontit S.L. no guarda relación con ninguna de las marcas aquí referenciadas, que son propiedad de sus respectivos titulares

---

**ADT**<sup>®</sup>  
AXUS  
DENTAL  
TECH





















# MIS<sup>®</sup> SEVEN<sup>®</sup>

NP Ø3.3 / SP / WP



	NP Ø3.3	SP Ø3.75 Ø4.25	WP Ø5.0 Ø6.0
	<b>Análogo</b>		
	HEM-33300	HEM-42300	HEI-45300
	<b>Tornillo análogo digital</b>		
M1,6 hex. 1,20	HE-41215	HE-41215	HE-41215
	<b>Transfer de impresión</b>		
Cubeta abierta (CA)	HEM-33700	HEI-35700	HEI-45700
Cubeta cerrada (CC)		HEI-35710	
	<b>Tapón de cicatrización</b>		
Alt. 2mm	HEM-33402	HEI-35402	
Alt. 3mm	HEM-33403	HEI-35403	HEI-45403
Alt. 4mm	HEM-33404	HEI-35404	HEI-45404
Alt. 5mm	HEM-33405	HEI-35405	
Alt. 6mm	HEM-33406		HEI-45405
	<b>Tornillo</b>		
M1.6 c/hex. 1.27	HEM-33200		
M1.6 c/hex. 1.27 DLC	HEM-33280		
M1.8 c/hex. 1.27		HEM-42200	HEM-42200
<b>M1,6 Tetralobular ACS</b>	IBO 1701 225		
<b>M1,8 Tetralobular ACS</b>		IBO 1501 225	IBO 1501 225
	<b>Calcinable</b>		
Antirrotatorio	HEM-33001	HEM-42001	HEI-45001
Rotatorio	HEM-33010	HEM-42010	HEI-45010
	<b>Calcinable base Cr-Co</b>		
Antirrotatorio	HEM-33110	HEI-35110	HEI-45110
Rotatorio	HEM-33100	HEI-35100	HEI-45100
	<b>Chimenea angulada base Cr-Co</b>		
17°	IBO 1102 011	IBO 1102 011	IBO 1102 011
30°	IBO 1102 012	IBO 1102 012	IBO 1102 012

	<b>NP Ø3.3</b>	<b>SP Ø3.75 Ø4.25</b>	<b>WP Ø5.0 Ø6.0</b>
	<b>Pilar provisional</b>		
Antirrotatorio	HEM-33600	HEI-35600	HEI-45600
Rotatorio	HEM-33610	HEI-35610	HEI-45610
	<b>Pilar recto / Ang</b>		
Recto Antirrotatorio		HEI-35505	
Ang. 15°		HEI-35650	
Ang. 25°		HEI-35651	
	<b>Scanbody</b>		
Intraoral titanio	IBO 1701 702	IBO 1501 702	IBO 1502 702
Laboratorio Peek	HEM-33770	HEI-35770	HEI-45770
	<b>Interfase 1G</b>		
Antirrotatorio		HEI-35751	HEI-45751
Rotatorio		HEI-35750	HEI-45750
	<b>Interfase AC 2G</b>		
Antirrotatoria alt. 0,5mm	IBO 1701 620	IBO 1501 620	IBO 1502 620
Antirrotatoria alt. 1,5mm		IBO 1501 622	IBO 1502 622
Antirrotatoria alt. 2,5mm		IBO 1501 624	
Rotatoria alt. 0,5mm	IBO 1701 621	IBO 1501 621	IBO 1502 621
Rotatoria alt. 1,5mm		IBO 1501 623	IBO 1502 623
Rotatoria alt. 2,5mm		IBO 1501 625	
	<b>Interfase 3G</b>		
Antirrotatoria alt. 0,5mm	HEM-33741	HEI-35741	HEI-45741
Antirrotatoria alt. 1,5mm	HEM-33743	HEI-35743	HEI-45743
Antirrotatoria alt. 2,5mm	HEM-33745	HEI-35745	
Rotatoria alt. 0,5mm	HEM-33740	HEI-35740	HEI-45740
Rotatoria alt. 1,5mm	HEM-33742	HEI-35742	HEI-45742
Rotatoria alt. 2,5mm	HEM-33744	HEI-35744	
	<b>Pilar Multiunit</b>		
Alt. 1mm	HEM-33801	HEI-35801	HEI-45801
Alt. 2mm	HEM-33802	HEI-35802	HEI-45802
Alt. 3mm	HEM-33803	HEI-35803	HEI-45803
Alt. 4mm	HEM-33804	HEI-35804	HEI-45804
Alt. 5mm		HEI-35805	HEI-45805
	<b>Pilar Multiunit angulado</b>		
17° alt. 2mm		HEI-35852	HEI-45852
17° alt. 3mm		HEI-35853	HEI-45853
17° alt. 4mm		HEI-35854	HEI-45854
30° alt. 4mm		HEI-35864	HEI-45864
30° alt. 5mm		HEI-35865	HEI-45865
30° alt. 6mm		HEI-35866	HEI-45866



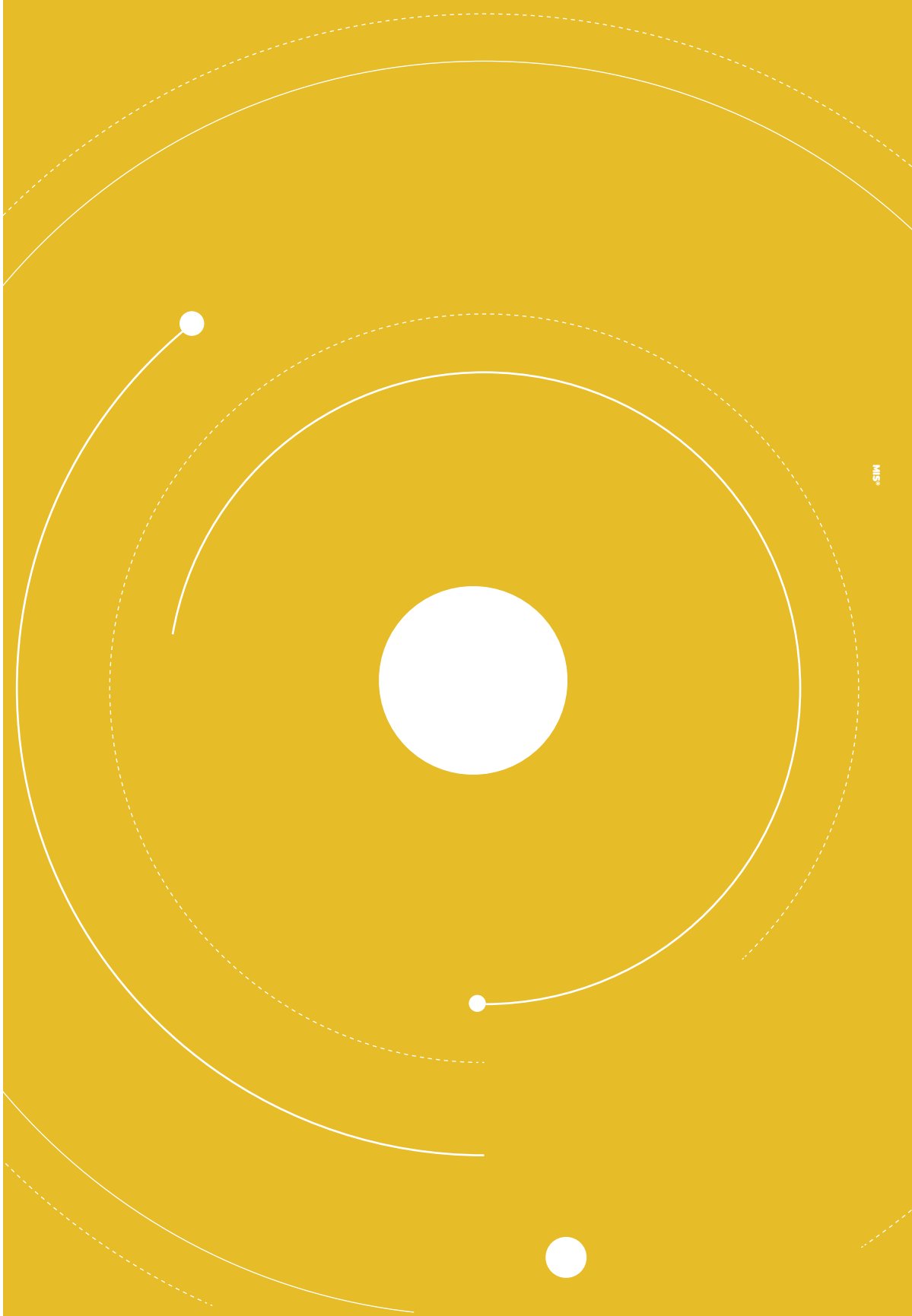

MIS®





# MIS<sup>®</sup> C1/V3<sup>®</sup>

SP

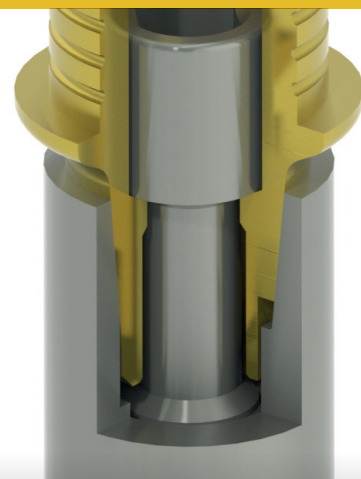

**SP Ø 3.75 / 4.2**



## Análogo

IBO 4002 300



## Tornillo análogo digital

M1,6 hex. 1,20

HE-41215



## Transfer de impresión

Cubeta abierta (CA)

IBO 4002 350



## Tapón de cicatrización

Alt. 2mm

IBO 4002 402

Alt. 3mm

IBO 4002 403

Alt. 4mm

IBO 4002 404

Alt. 5mm

IBO 4002 405



## Tornillo

M1,8 hex. 1.20

IBO 4002 200

**M1,8 Tetralobular ACS**

IBO 1501 225



## Calcinable base Cr-Co

Antirrotatorio

IBO 4002 110

Rotatorio

IBO 4002 100



## Chimenea angulada base Cr-Co

17°

IBO 1102 011

30°

IBO 1102 012



## Pilar provisional

Antirrotatorio

IBO 4002 550

Rotatorio

IBO 4002 555



**SP Ø 3.75 / 4.2****Scanbody**

Intraoral titanio

IBO 4002 702

**Interfase AC 2G**Antirrotatoria  
Rotatoria

IBO 4002 620

IBO 4002 621

**Interfase 3G**

Antirrotatoria alt. 0,7 mm.

IBO 4002 601

Antirrotatoria alt. 1,5 mm.

IBO 4002 603

Antirrotatoria alt. 2,5 mm.

IBO 4002 605

Rotatoria alt. 0,7 mm.

IBO 4002 600

Rotatoria alt. 1,5 mm.

IBO 4002 602

Rotatoria alt. 2,5 mm.

IBO 4002 604

**Pilar Multiunit**

Alt. 1 mm

IBO 4002 801

Alt. 2 mm

IBO 4002 802

Alt. 3 mm

IBO 4002 803

Alt. 4 mm

IBO 4002 804

**Pilar Lock-Attach**

Alt. 1 mm

IBO 4002 901

Alt. 2 mm

IBO 4002 902

Alt. 3 mm

IBO 4002 903

Alt. 4 mm

IBO 4002 904



# SWEDEN & MARTINA®

**HES** CAD/CAM 2700  
PREMIUM KOHNO®

---

Ibodontit S.L. no guarda relación con ninguna de las marcas aquí referenciadas,  
que son propiedad de sus respectivos titulares

---

**ADT**®  
AXUS  
DENTAL  
TECH









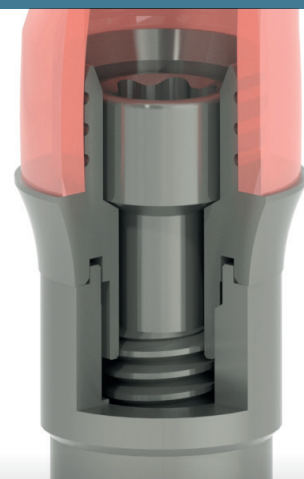



# SWEDEN & MARTINA<sup>®</sup> PREMIUM KHONO<sup>®</sup>

Ø3.3 / Ø3.8 / Ø4.25 / Ø5.0



	Ø3.3	Ø3.8	Ø4.25	Ø5.0
	<b>Análogo</b>			
	HES-33300	HES-38300	HES-43300	HES-50300
	<b>Tornillo análogo digital</b>			
M1,6 hex. 1,20	HE-41215	HE-41215	HE-41215	HE-41215
	<b>Transfer de impresión</b>			
Cubeta abierta (CA)	HES-33700	HES-38700	HES-43700	
	<b>Tapón de cicatrización</b>			
Alt. 3mm	HES-33403	HES-38403	HES-43403	
Alt. 5mm	HES-33405	HES-38405	HES-43405	
Alt. 6mm		HES-38406	HES-43406	
	<b>Tornillo</b>			
M1,8 hex 1,27	HES-38200	HES-38200		
M1,8 hex 1,27 DLC	HES-38280	HES-38280		
M2 hex 1,27			HES-43200	HES-43200
M2 hex 1,27 DLC			HES-43280	HES-43280
M1,8 Tetralobular ACS	IBO 2702 225	IBO 2702 225		
M2 Tetralobular ACS			IBO 2703 225	IBO 2703 225
	<b>Calcinable</b>			
Antirrotatorio	HES-33001	HES-38001	HES-43001	HES-50001
Rotatorio	HES-33010	HES-38010	HES-43010	HES-50010
	<b>Calcinable Base Cr-Co</b>			
Antirrotatorio	HES-33110	HES-38110	HES-43110	
Rotatorio	HES-33100	HES-38100	HES-43100	
	<b>Chimenea angulada base Cr-Co</b>			
17°	IBO 1102 011	IBO 1102 011	IBO 1102 011	
30°	IBO 1102 012	IBO 1102 012	IBO 1102 012	

Ø3.3                      Ø3.8                      Ø4.25                      Ø5.0



**Pilar provisional**

Antirrotatorio	HES-33600	HES-38600	HES-43600
Rotatorio	HES-33610	HES-38610	HES-43610



**Pilar recto**

Antirrotatorio	HES-38500	HES-43500	HES-50500
----------------	-----------	-----------	-----------



**Scanbody**

Intraoral titanio	IBO 2701 702	IBO 2702 702	IBO 2703 702	IBO 2704 702
Laboratorio Peek	HES-33770	HES-38770	HES-43770	



**Interfase AC 2G**

Antirrotatoria	IBO 2701 620	IBO 2702 620	IBO 2703 620
Rotatoria	IBO 2701 621	IBO 2702 621	IBO 2703 621



**Interfase 3G**

Antirrotatoria alt. 0,5mm	HES-33741	HES-38741	HES-43741
Antirrotatoria alt. 1,5mm	HES-33743	HES-38743	HES-43743
Rotatoria alt. 0,5mm	HES-33740	HES-38740	HES-43740
Rotatoria alt. 1,5mm	HES-33742	HES-38742	HES-33742



**Pilar Multiunit**

Alt. 1mm	HES-33801	HES-38801	HES-43801
Alt. 2mm	HES-33802	HES-38802	HES-43802
Alt. 3mm	HES-33803	HES-38803	HES-43803
Alt. 4mm	HES-33804	HES-38804	HES-43804



**Pilar Multiunit angulado**

17° alt. 2,5mm	HES-33852	HES-38852	HES-43852
17° alt. 3,5mm	HES-33853	HES-38853	HES-43853
30° alt. 3,5mm	HES-33863	HES-38863	HES-43863
30° alt. 4,5mm	HES-33864	HES-38864	HES-43864



**Pilar Lock-Attach**

Alt. 1mm	HES-33901	HES-38901	HES-43901
Alt. 2mm	HES-33902	HES-38902	HES-43902
Alt. 3mm	HES-33903	HES-38903	HES-43903
Alt. 4mm	HES-33904	HES-38904	HES-43904



# KLOCKNER®

**HEV** CAD/CAM 2300  
SK2-NK2®

**HEV** CAD/CAM 2400  
ESSENTIAL®

CAD/CAM 4100  
VEGA®

---

Ibodontit S.L. no guarda relación con ninguna de las marcas aquí referenciadas,  
que son propiedad de sus respectivos titulares

---

**ADT**®  
AXUS  
DENTAL  
TECH



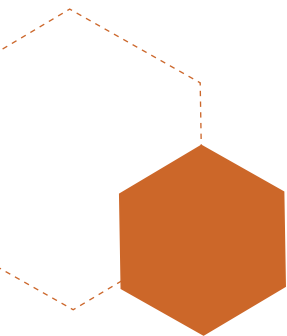

# KLOCKNER® SK2-NK2®

Ø4.2



## SK2 - NK2 Ø4.2



### Análogo

HEV-42300



### Tornillo análogo digital

M1,6 hex. 1,20

HE-41215



### Transfer de impresión

Cubeta abierta (CA)  
Cubeta cerrada (CC)

HEV-42700  
HEV-42710



### Tapón de cicatrización

Alt. 4,5mm  
Alt. 5,5mm

HEV-42404  
HEV-42505



### Tornillo

M1.8 c/hex. 1.70  
M1.8 cruciforme

HEV-42200  
HEV-42201

M1,8 Tetralobular ACS

IBO 2301 225



### Calcinable

Antirrotatorio  
Rotatorio

HEV-42001  
HEV-42010



### Calcinable base Cr-Co

Antirrotatorio  
Rotatorio

HEV-42110  
HEV-42100



### Pilar recto

Antirrotatorio  
Rotatorio

HEV-42500  
HEV-42550



**SK2 - NK2 Ø4.2****Scanbody**

Intraoral titanio  
Laboratorio Peek

IBO 2301 702  
HEV-42770

**Interfase 1G**

Antirrotatorio  
Rotatorio

HEV-42751  
HEV-42750

**Interfase AC 2G**

Antirrotatoria  
Rotatoria

IBO 2301 620  
IBO 2301 621

**Pilar Lock-Attach**

Alt. 2,5mm  
Alt. 3,5mm  
Alt. 4,5mm  
Alt. 5,5mm

HEV-42902  
HEV-42903  
HEV-42904  
HEV-42905

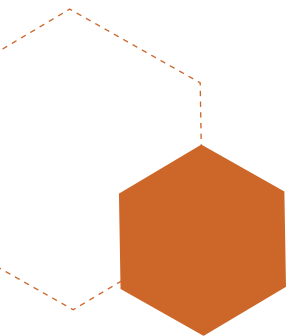

# KLOCKNER<sup>®</sup> ESSENTIAL<sup>®</sup>

Ø4.5

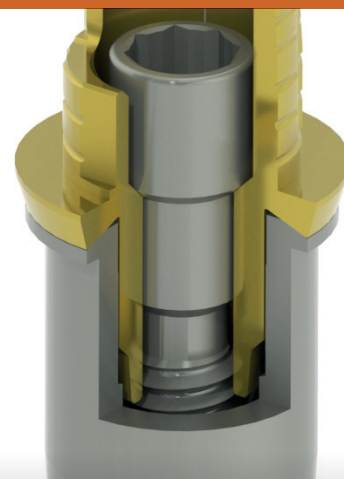

**RP Ø4.5**



## Análogo

HEV-45300



## Tornillo análogo digital

M1,6 hex. 1,20

HE-41215



## Tornillo

M1,8 c/Estrella

HEV-45200

**M1,8 Tetralobular ACS**

IBO 2401 225



## Calcinable

Antirrotatorio  
Rotatorio

HEV-45001  
HEV-45010



## Calcinable base Cr-Co

Antirrotatorio  
Rotatorio

HEV-45110  
HEV-45100



## Chimenea angulada base Cr-Co

17°  
30°

IBO 1102 013  
IBO 1102 014



## Scanbody

Intraoral titanio  
Laboratorio Peek

IBO 2401 702  
HEV-45770



## Interfase AC 2G

Antirrotatorio  
Rotatorio

IBO 2401 620  
IBO 2401 621

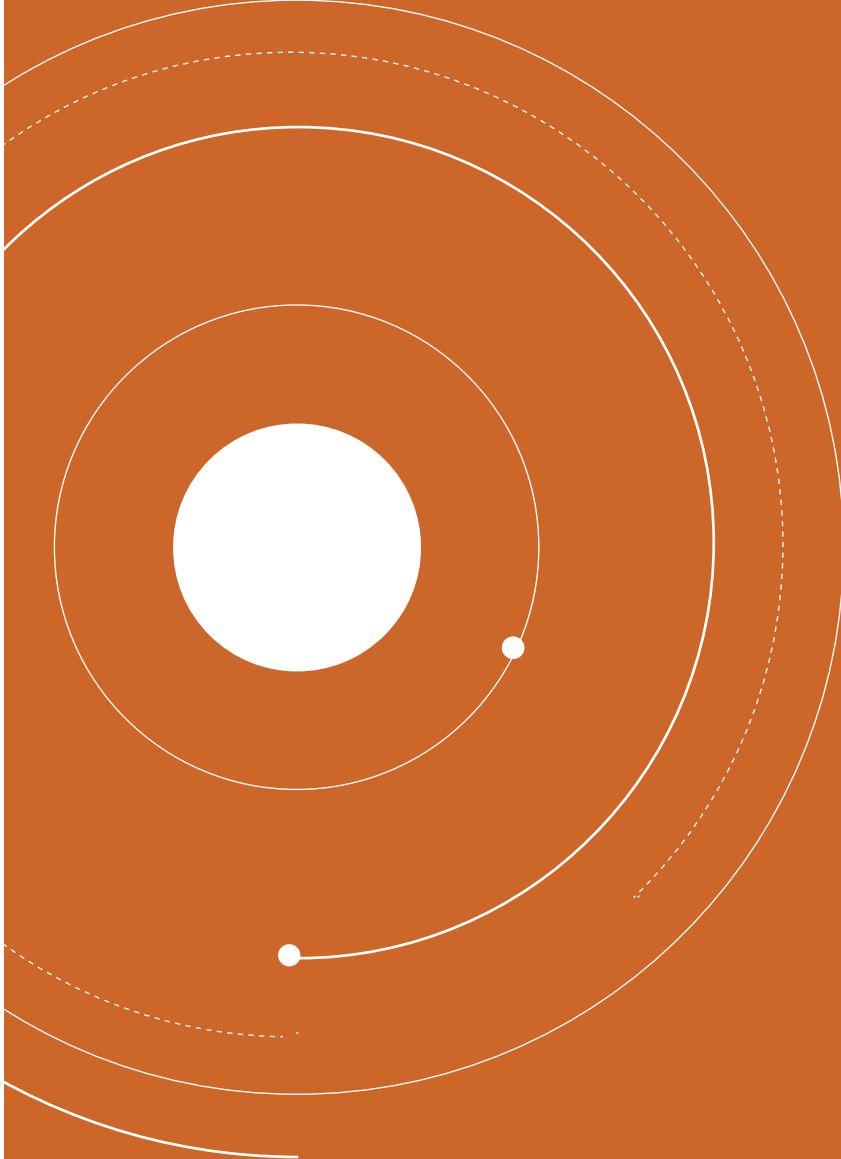

# KLOCKNER® VEGA®

Ø3.5 / Ø4.0 / Ø4.5



	Ø3.5	Ø4.0 - 4.5
	<b>Análogo</b>	
	IBO 4101 300	IBO 4102 300
	<b>Tornillo análogo digital</b>	
M1,6 hex. 1,20	HE-41215	HE-41215
	<b>Transfer de impresión</b>	
Cubeta abierta (CA)	IBO 4101 350	IBO 4102 350
	<b>Tornillo</b>	
M1,6 c/Estrella M Especial c/Estrella	IBO 4101 200	IBO 4102 200
<b>M1,8 Tetralobular ACS</b> <b>M Especial Tetralobular ACS</b>	IBO 4101 225	IBO4102 225
	<b>Calcinable base Cr-Co</b>	
Antirrotatorio Rotatorio	IBO 4101 110 IBO 4101 100	IBO 4102 110 IBO 4102 100
	<b>Chimenea angulada base Cr-Co</b>	
17° 30°	IBO 1102 011 IBO 1102 012	IBO 1102 011
	<b>Pilar provisional</b>	
Antirrotatorio Rotatorio	IBO 4101 550 IBO 4101 555	IBO 4102 550 IBO 4102 555
	<b>Scanbody</b>	
Intraoral titanio	IBO 4101 702	IBO 4102 702

Ø3.5

Ø4.0 - 4.5



### Interfase AC 2G

Antirrotatoria	IBO 4101 620	IBO 4102 620
Rotatoria	IBO 4101 621	IBO 4102 621



### Interfase 3G

Antirrotatoria alt. 0,7 mm.	IBO 4101 601	IBO 4102 601
Antirrotatoria alt. 1,5 mm.	IBO 4101 603	IBO 4102 603
Antirrotatoria alt. 2,5 mm.	IBO 4101 605	IBO 4102 605
Rotatoria alt. 0,7 mm.	IBO 4101 600	IBO 4102 600
Rotatoria alt. 1,5 mm.	IBO 4101 602	IBO 4102 602
Rotatoria alt. 2,5 mm.	IBO 4101 604	IBO 4102 604



### Pilar Multiunit

Alt. 1,5mm	IBO 4101 801	IBO 4102 801
Alt. 2,5mm	IBO 4101 802	IBO 4102 802
Alt. 3,5mm	IBO 4101 803	IBO 4102 803
Alt. 4,5mm	IBO 4101 804	IBO 4102 804



### Pilar Multiunit angulado

17° alt. 2,5mm	IBO 4101 852	IBO 4102 852
30° alt. 3,5mm	IBO 4101 863	IBO 4102 863



### Pilar Lock-Attach

Alt. 1mm	IBO 4101 901	IBO 4102 901
Alt. 2mm	IBO 4101 902	IBO 4102 902
Alt. 3mm	IBO 4101 903	IBO 4102 903
Alt. 4mm	IBO 4101 904	IBO 4102 904
Alt. 5mm	IBO 4101 905	IBO 4102 905



# BIOHORIZONS®

**HEI**

**CAD/CAM 1600  
TAPERED INTERNAL®**

---

Ibodontit S.L. no guarda relación con ninguna de las marcas aquí referenciadas,  
que son propiedad de sus respectivos titulares

---

**ADT**®  
AXUS  
DENTAL  
TECH



# BIOHORIZONS<sup>®</sup>

## TAPERED INTERNAL<sup>®</sup>

Ø3.0 / Ø3.5 / Ø4.5



	Ø3.0	Ø3.5	Ø4.5
	<b>Análogo</b>		
	IBO 1601 300	HEI-35300	HEI-45300
	<b>Tornillo análogo digital</b>		
M1,6 hex 1,20	HE-41215	HE-41215	HE-41215
	<b>Transfer de impresión</b>		
Cubeta abierta (CA)	IBO 1601 350	HEI-35700	HEI-45700
Cubeta cerrada (CC)		HEI-35710	
	<b>Tornillo transfer</b>		
Cubeta abierta (CA)		HEI-35701	
Cubeta cerrada (CC)		HEI-35711	
	<b>Tapón de cicatrización</b>		
Alt. 2mm		HEI-35402	
Alt. 3mm	IBO 1601 403	HEI-35403	HEI-45403
Alt. 4mm		HEI-35404	HEI-45404
Alt. 5mm	IBO 1601 405	HEI-35405	HEI-45405
	<b>Tornillo</b>		
M1.8 c/hex. 1.27	IBO 1601 200	HEI-35201	HEI-35201
M1.8 c/hex. 1.27 DLC		HEI-35280	HEI-35280
<b>M1,8 Tetralobular ACS</b>	IBO 1501 225	IBO 1501 225	IBO 1501 225
	<b>Calcinable</b>		
Antirrotatorio		HEI-35001	HEI-45001
Rotatorio		HEI-35010	HEI-45010





	Ø3.0	Ø3.5	Ø4.5
<b>Calcinable base Cr-Co</b>			
Antirrotatorio	IBO 1601 110	HEI-35110	HEI-45110
Rotatorio	IBO 1601 100	HEI-35100	HEI-45100



	Ø3.0	Ø3.5	Ø4.5
<b>Chimenea angulada base Cr-Co</b>			
17°	IBO 1102 011	IBO 1102 011	IBO 1102 011
30°	IBO 1102 012	IBO 1102 012	IBO 1102 012



	Ø3.0	Ø3.5	Ø4.5
<b>Pilar provisional</b>			
Antirrotatorio	IBO 1601 550	HEI-35600	HEI-45600
Rotatorio	IBO 1601 555	HEI-35610	HEI-45610



	Ø3.0	Ø3.5	Ø4.5
<b>Scanbody</b>			
Intraoral titanio	IBO 1601 702	IBO 1501 702	IBO 1502 702
Laboratorio Peek		HEI-35770	HEI-45770



	Ø3.0	Ø3.5	Ø4.5
<b>Interfase 1G</b>			
Antirrotatorio		HEI-35751	HEI-45751
Rotatorio		HEI-35750	HEI-45750



	Ø3.0	Ø3.5	Ø4.5
<b>Interfase AC 2G</b>			
Antirrotatoria alt. 0,5 mm.		IBO 1501 620	IBO 1502 620
Antirrotatoria alt. 1,5 mm.		IBO 1501 622	IBO 1502 622
Antirrotatoria alt. 2,5 mm.		IBO 1501 624	
Rotatoria alt. 0,5 mm.		IBO 1501 621	IBO 1502 621
Rotatoria alt. 1,5 mm.		IBO 1501 623	IBO 1502 623
Rotatoria alt. 2,5 mm.		IBO 1501 625	



	Ø3.0	Ø3.5	Ø4.5
<b>Interfase 3G</b>			
Antirrotatoria alt. 0,5 mm.	IBO 1601 601	HEI-35741	HEI-45741
Antirrotatoria alt. 1,5 mm.	IBO 1601 603	HEI-35743	HEI-45743
Antirrotatoria alt. 2,5 mm.	IBO 1601 605	HEI-35745	
Rotatoria alt. 0,5 mm.	IBO 1601 600	HEI-35740	HEI-45740
Rotatoria alt. 1,5 mm.	IBO 1601 602	HEI-35742	HEI-45742
Rotatoria alt. 2,5 mm.	IBO 1601 604	HEI-35744	



	Ø3.0	Ø3.5	Ø4.5
<b>Pilar Multiunit</b>			
Alt. 1mm		HEI-35801	HEI-45801
Alt. 2mm		HEI-35802	HEI-45802
Alt. 3mm		HEI-35803	HEI-45803
Alt. 4mm		HEI-35804	HEI-45804
Alt. 5mm		HEI-35805	HEI-45805

Ø3.0

Ø3.5

Ø4.5



**Pilar Multiunit angulado**

17° alt. 2mm	HEI-35852	HEI-45852
17° alt. 3mm	HEI-35853	HEI-45853
17° alt. 4mm	HEI-35854	HEI-45854
30° alt. 4mm	HEI-35864	HEI-45864
30° alt. 5mm	HEI-35865	HEI-45865
30° alt. 6mm	HEI-35866	HEI-45866



**Pilar Lock-Attach**

Alt. 1mm	HEI-35901	HEI-45901
Alt. 2mm	HEI-35902	HEI-45902
Alt. 3mm	HEI-35903	HEI-45903
Alt. 4mm	HEI-35904	HEI-45904
Alt. 5mm	HEI-35905	HEI-45905
Alt. 6mm	HEI-35906	HEI-45906



Angulado alt. 1,5mm  
Angulado alt. 3mm

HEI-35951  
HEI-35953

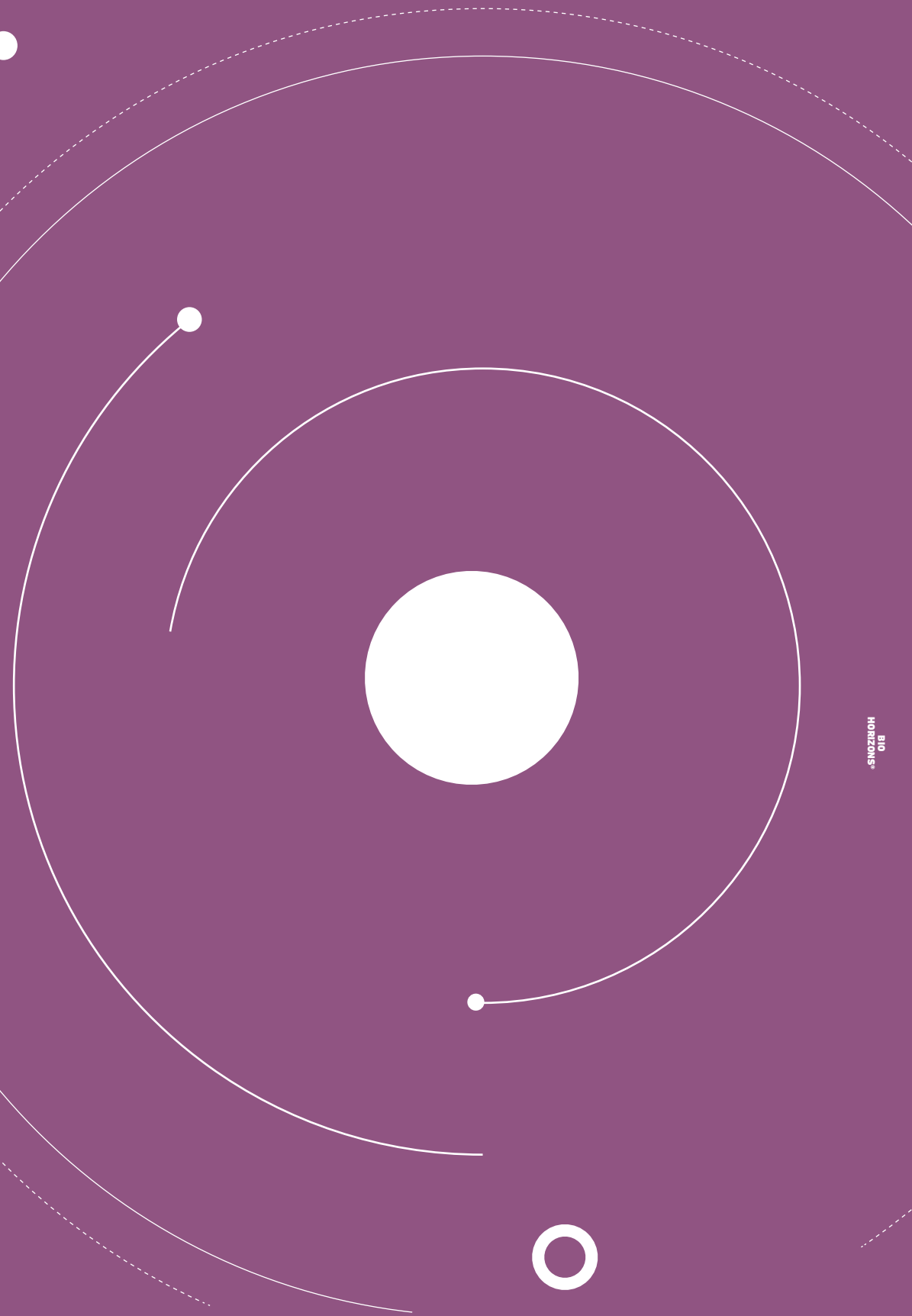



# DENTSPLY®

CAD/CAM 3100  
FRIADENT XIVE®

CAD/CAM 3500  
ANKYLOS C/X®

---

Ibodontit S.L. no guarda relación con ninguna de las marcas aquí referenciadas,  
que son propiedad de sus respectivos titulares

---

ADT®  
AXUS  
DENTAL  
TECH



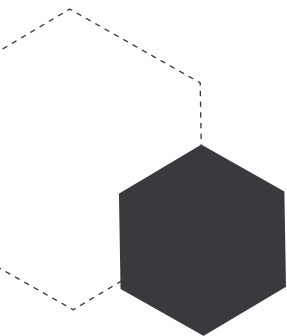

# DENTSPLY<sup>®</sup> FRIADENT XIVE<sup>®</sup>

Ø3.4 / Ø3.8 / Ø4.5



	Ø3.4	Ø3.8	Ø4.5
	<b>Análogo</b>		
	IBO 3101 300	IBO 3102 300	IBO 3103 300
	<b>Tornillo análogo digital</b>		
M1,6 hex. 1,20	HE-41215	HE-41215	HE-41215
	<b>Transfer de impresión</b>		
Cubeta abierta (CA)	IBO 3101 350	IBO 3102 350	IBO 3103 350
	<b>Tapón de cicatrización</b>		
Alt. 3mm	IBO 3101 403	IBO 3102 403	IBO 3102 403
Alt. 5mm	IBO 3101 405	IBO 3102 405	IBO 3102 405
	<b>Tornillo</b>		
M1,6 hex 1,20	IBO 3102 200	IBO 3102 200	IBO 3102 200
M1,6 hex 1,20 DLC	IBO 3102 280	IBO 3102 280	IBO 3102 280
<b>M1,6 Tetralobular ACS M6</b>	IBO 3102 225	IBO 3102 225	IBO 3102 225
	<b>Calcinable</b>		
Antirrotatorio	IBO 3101 001	IBO 3102 001	IBO 3103 001
Rotatorio	IBO 3101 010	IBO 3102 010	IBO 3103 010
	<b>Calcinable base Cr-Co</b>		
Antirrotatorio	IBO 3101 110	IBO 3102 110	IBO 3103 110
Rotatorio	IBO 3101 100	IBO 3102 100	IBO 3103 100
	<b>Scanbody</b>		
Intraoral titanio	IBO 3101 702	IBO 3102 702	IBO 3103 702
Laboratorio Peek	IBO 3101 700	IBO 3102 700	IBO 3103 700



### Interfase AC 2G

	Ø3.4	Ø3.8	Ø4.5
Antirrotatorio	IBO 3101 620	IBO 3102 620	IBO 3103 620
Rotatorio	IBO 3101 621	IBO 3102 621	IBO 3103 621



### Interfase 3G

Antirrotatoria alt. 0,5mm		IBO 3102 601	
Antirrotatoria alt. 1,5mm		IBO 3102 603	
Rotatoria alt. 0,5mm		IBO 3102 600	
Rotatoria alt. 1,5mm		IBO 3102 602	



### Pilar Multiunit

Alt. 1mm	IBO 3101 801	IBO 3102 801	IBO 3103 801
Alt. 2mm	IBO 3101 802	IBO 3102 802	IBO 3103 802
Alt. 3mm	IBO 3101 803	IBO 3102 803	IBO 3103 803
Alt. 4mm	IBO 3101 804	IBO 3102 804	IBO 3103 804



### Pilar Lock-Attach

Alt. 1mm	IBO 3101 901	IBO 3102 901	IBO 3103 901
Alt. 2mm	IBO 3101 902	IBO 3102 902	IBO 3103 902
Alt. 3mm	IBO 3101 903	IBO 3102 903	IBO 3103 903
Alt. 4mm	IBO 3101 904	IBO 3102 904	IBO 3103 904

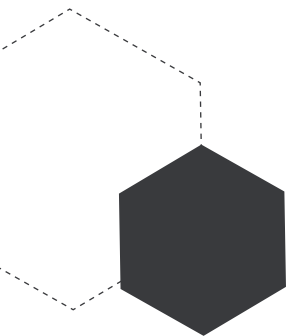

# DENTSPLY<sup>®</sup> ANKYLOS<sup>®</sup>

C/X

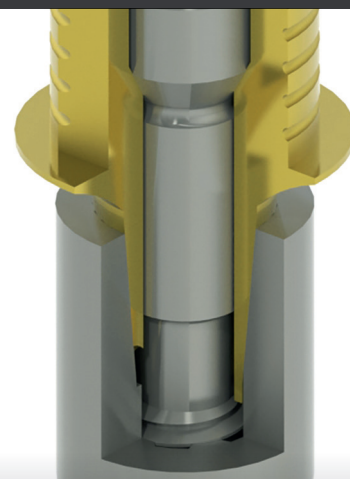

Ø3.5 / 4.5 / 5.5 / 7.0



## Análogo

IBO 3502 300



## Tornillo análogo digital

M1,6 hex. 1,20

HE-41215



## Transfer de impresión

Cubeta abierta (CA)

IBO 3502 350



## Tapón de cicatrización

Alt. 2mm  
Alt. 3,5mm  
Alt. 5mm

IBO 3402 402  
IBO 3402 403  
IBO 3402 404



## Tornillo

M1,8 para rotativo

IBO 3502 200



## Calcinable

Antirrotatorio  
Rotatorio

IBO 3502 001  
IBO 3502 010



## Calcinable base Cr-Co

Antirrotatorio  
Rotatorio

IBO 3502 110  
IBO 3502 100



## Pilar provisional

Antirrotatorio  
Rotatorio

IBO 3502 550  
IBO 3502 555



Ø3.5 / 4.5 / 5.5 / 7.0



### Scanbody

Intraoral titanio  
Laboratorio Peek

IBO 3502 702  
IBO 3502 700



### Interfase AC 2G

Antirrotatoria alt 1 mm.  
Rotatoria alt 1 mm.

IBO 3502 620  
IBO 3502 621



### Pilar Multiunit

Alt. 1,5mm  
Alt. 2,5mm  
Alt. 3,5mm  
Alt. 4,5mm

IBO 3402 801  
IBO 3402 802  
IBO 3402 803  
IBO 3402 804



### Pilar Lock-Attach

Alt. 2mm  
Alt. 3mm  
Alt. 4mm  
Alt. 5mm

IBO 3402 902  
IBO 3402 903  
IBO 3402 904  
IBO 3402 905

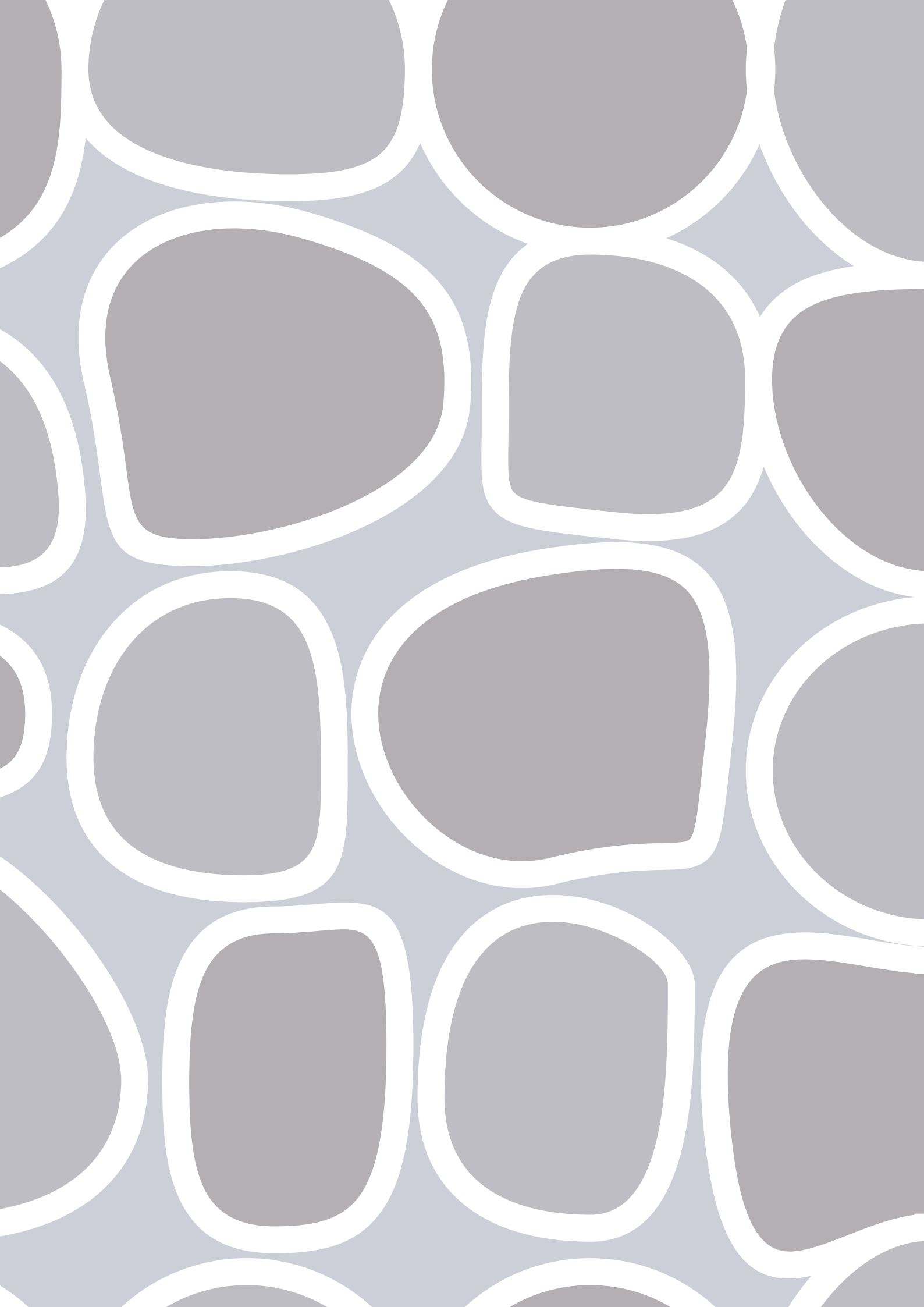

# BTI®

**HEB** CAD/CAM 2600  
HEX EXTERNO®

**HEB** CAD/CAM 2500  
INTERNA®

---

Ibodontit S.L. no guarda relación con ninguna de las marcas aquí referenciadas,  
que son propiedad de sus respectivos titulares

---

**ADT**®  
AXUS  
DENTAL  
TECH



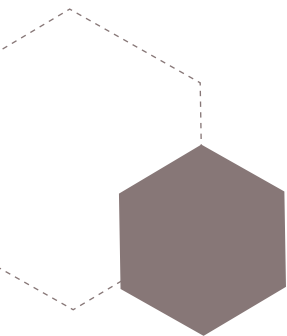

# BTI<sup>®</sup> HEX.EXTERNO<sup>®</sup>

Ø3.5 / Ø4.1

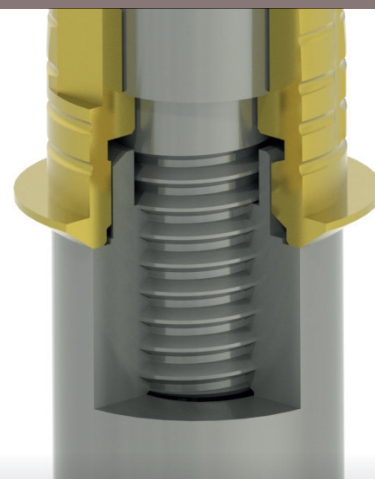

	<i>NP Ø3.5</i>	<i>RP Ø4.1</i>
	<b>Análogo</b>	
	HEB-35300	HE-41300
	<b>Tornillo análogo digital</b>	
M1,6 hex. 1,20	HE-41215	HE-41215
	<b>Transfer de impresión</b>	
Cubeta abierta (CA) Cubeta cerrada (CC)		HE-41700 HE-41710
	<b>Tapón de cicatrización</b>	
Alt. 2mm Alt. 3mm Alt. 4mm Alt. 5mm		HE-41402 HE-41403 HE-41404 HE-41405
	<b>Tornillo</b>	
M2 hex. 1,20 M2 hex. 1,20 DLC	HEB-35200 HE-41280	HE-41200 HE-41280
<b>M1,8 Tetralobular ACS</b>	IBO 1102 225	IBO 1102 225
	<b>Calcinable</b>	
Antirrotatorio Rotatorio	HEB-35001 HEB-35010	HE-41001 HE-41010
	<b>Calcinable base Cr-Co</b>	
Antirrotatorio Rotatorio		HE-41110 HE-41100
	<b>Chimenea angulada base Cr-Co</b>	
17° 30°		IBO 1102 011 IBO 1102 012

NP Ø3,5

RP Ø4,1

**Scanbody**

Intraoral titanio  
Laboratorio Peek

IBO 2601 702  
HEB-35770

IBO 1102 702  
HE-41770

**Interfase 1G**

Antirrotatoria  
Rotatoria

HE-41751  
HE-41750

**Interfase AC 2G**

Antirrotatoria alt 0,5 mm  
Antirrotatoria alt 1,5 mm  
Antirrotatoria alt 2,5 mm  
Rotatoria alt 0,5 mm  
Rotatoria alt 1,5 mm  
Rotatoria alt 2,5 mm

IBO 2601 620

IBO 2601 621

IBO 1102 620  
IBO 1102 622  
IBO 1102 624  
IBO 1102 621  
IBO 1102 623  
IBO 1102 625

**Interfase 3G**

Antirrotatoria alt 0,5 mm  
Antirrotatoria alt 1,5 mm  
Antirrotatoria alt 2,5 mm  
Rotatoria alt 0,5 mm  
Rotatoria alt 1,5 mm  
Rotatoria alt 2,5 mm

HE-41741  
HE-41743  
HE-41745  
HE-41740  
HE-41742  
HE-41744

**Pilar Multiunit**

Alt. 1mm  
Alt. 2mm  
Alt. 3mm  
Alt. 4mm  
Alt. 5mm

HE-48801  
HE-48802  
HE-48803  
HE-48804  
HE-48805

**Pilar Multiunit angulado**

17° alt. 2mm  
17° alt. 3mm  
17° alt. 4mm  
30° alt. 3mm  
30° alt. 4mm  
30° alt. 5mm

HE-48852  
HE-48853  
HE-48854  
HE-48863  
HE-48864  
HE-48865

**Pilar Lock-Attach**

Alt. 0,73mm  
Alt. 2mm  
Alt. 3mm  
Alt. 4mm  
Alt. 5mm  
Alt. 6mm

HE-41901  
HE-41902  
HE-41903  
HE-41904  
HE-41905  
HE-41906



Angulado alt. 1,5mm  
Angulado alt. 3mm

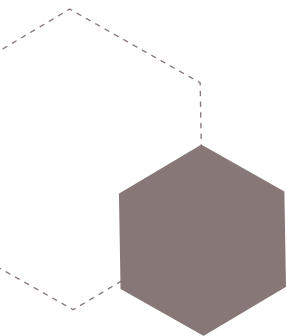

HE-41951  
HE-41953

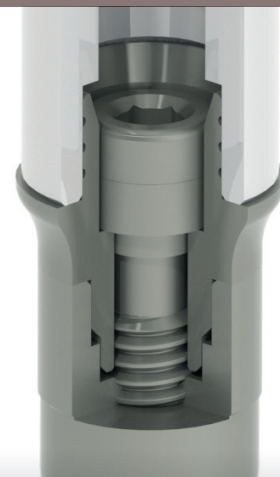

# BTI<sup>®</sup> INTERNA<sup>®</sup>

Ø4.1 UNIVERSAL / Ø5.5 ANCHA



	<i>RP Ø4.1</i>	<i>WP Ø5.5</i>
	<b>Análogo</b>	
Normal	HEB-41300	HEB-55300
Multi IM	HEB-41301	
	<b>Tornillo análogo digital</b>	
M1,6 hex. 1,20	HE-41215	HE-41215
	<b>Transfer de impresión</b>	
Cubeta abierta (CA)	HEB-41700	HEB-55700
Cubeta abierta Multi IM (CA)	HEB-41701	
	<b>Tapón de cicatrización</b>	
Alt.2 mm.	HEB-41402	
Alt.3 mm.	HEB-41403	
Alt.4 mm.	HEB-41404	
Alt.5 mm.	HEB-41405	
Alt.6 mm.	HEB-41406	
Alt.8 mm.	HEB-41408	
Multi IM	HEB-41420	
	<b>Tornillo</b>	
M1,8 hex. 1.20	HEB-41200	HEB-41200
M1,8 hex. 1.20 Oro	HEB-41206	HEB-41206
M1.8 Unigrip DLC	HEB-41280	HEB-41280
Multi IM	HEB-41208	
M1.8 Tetralobular ACS	IBO 2501 225	IBO 2501 225
<b>Tetralobular ACS Multi Im</b>	<b>IBO 2501 226</b>	
	<b>Calcinable</b>	
Antirrotatorio	HEB-41001	HEB-55001
Rotatorio	HEB-41010	HEB-55010

RP Ø4.1

WP Ø5.5



### Calcinable base Cr-Co

Antirrotatorio	HEB-41100	HEB-55100
Rotatorio	HEB-41110	HEB-55110



### Chimenea angulada base Cr-Co

17°	IBO 1102 013	IBO 1102 011
30°	IBO 1102 014	IBO 1102 012



### Pilar provisional

Antirrotatorio	HEB-41600	HEB-55600
Rotatorio	HEB-41610	HEB-55610



### Scanbody

Intraoral titanio	IBO 2501 702	IBO 2502 702
Laboratorio Peek	HEB-41770	HEB-55770
Intraoral Multi IM Titanio	IBO 2501 703	



### Interfase AC 2G

Antirrotatoria	IBO 2501 620	IBO 2502 620
Rotatoria	IBO 2501 621	IBO 2502 621



### Interfase 3G

Antirrotatoria alt. 0,5mm	HEB-41741	
Antirrotatoria alt. 1,5mm	HEB-41743	
Rotatoria alt. 0,5mm	HEB-41740	
Rotatoria alt. 1,5mm	HEB-41742	
Multi IM	HEB-41758	



### Pilar Multiunit

Alt. 0mm	HEB-41800	HEB-55801
Alt. 1mm	HEB-41801	HEB-55802
Alt. 2mm	HEB-41802	HEB-55803
Alt. 3mm	HEB-41803	HEB-55804
Alt. 4mm	HEB-41804	
Alt. 5mm	HEB-41805	



### Pilar Multiunit angulado

17° alt. 2 mm	HEB-41852	
17° alt. 3 mm	HEB-41853	
30° alt. 3 mm	HEB-41863	
30° alt. 4 mm	HEB-41864	



### Pilar Lock-Attach

Alt. 1mm	HEB-41901	
Alt. 2mm	HEB-41902	
Alt. 3mm	HEB-41903	
Alt. 4mm	HEB-41904	
Alt. 5mm	HEB-41905	
Alt. 6mm	HEB-41906	





# MICRODENT®

CAD/CAM 3300  
SYSTEM®

---

Ibodontit S.L. no guarda relación con ninguna de las marcas aquí referenciadas,  
que son propiedad de sus respectivos titulares

---

ADT®  
AXUS  
DENTAL  
TECH



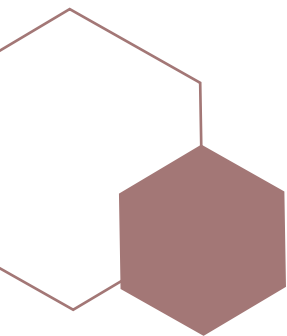

# MICRODENT<sup>®</sup> SYSTEM<sup>®</sup>

Ø4.2 / Ø5.1



	Ø4.2	Ø5.1
	<b>Análogo</b>	
	IBO 3302 300	IBO 3303 300
	<b>Tornillo análogo digital</b>	
M1,6 hex. 1,20	HE-41215	HE-41215
	<b>Transfer de impresión</b>	
Cubeta abierta (CA)	IBO 3302 350	IBO 3303 350
	<b>Tapón de cicatrización</b>	
Alt. 3mm Alt. 5mm	IBO 3302 405	IBO 3303 403 IBO 3303 405
	<b>Tornillo</b>	
M2 hex. 1,75 M2 hex. 1,20	IBO 3302 201 HE-41200	IBO 3302 201 HE-41200
<b>M2 Tetralobular ACS</b>	IBO 1102 225	IBO 1102 225
	<b>Calcinable</b>	
Antirrotatorio Rotatorio	IBO 3302 001 IBO 3302 010	IBO 3303 001 IBO 3303 010
	<b>Calcinable base Cr-Co</b>	
Antirrotatorio Rotatorio	IBO 3302 110 IBO 3302 100	
	<b>Chimenea angulada base Cr-Co</b>	
17° 30°	IBO 1102 011 IBO 1102 012	

Ø4.2

Ø5.1

**Scanbody**

Intraoral titanio

IBO 3302 702

**Interfase AC 2G**Antirrotatoria  
RotatoriaIBO 3302 620  
IBO 3302 621**Pilar Multiunit Recto**

Alt. 1,5mm

IBO 3302 801

**Pilar Lock-Attach**Alt. 2mm  
Alt. 3mm  
Alt. 4mmIBO 3302 902  
IBO 3302 903  
IBO 3302 904IBO 3303 902  
IBO 3303 903  
IBO 3303 904



# PHIBO®

**HPH** CAD/CAM 2900  
TSH®

---

Ibodontit S.L. no guarda relación con ninguna de las marcas aquí referenciadas,  
que son propiedad de sus respectivos titulares

---

**ADT**®  
AXUS  
DENTAL  
TECH



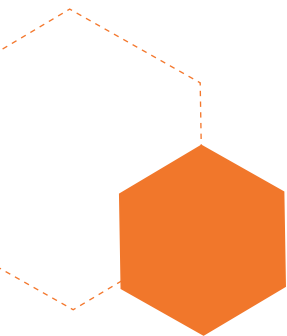

# PHIBO<sup>®</sup> TSH<sup>®</sup>

S2 / S3 - S4



	S2 Ø3.3	S3-S4 Ø3.75 Ø4.1
	<b>Análogo</b>	
	HPH-33300	HE-41300
	<b>Tornillo análogo digital</b>	
M1,6 hex. 1,20	HE-41215	HE-41215
	<b>Transfer de impresión</b>	
Cubeta abierta (CA) Cubeta cerrada (CC)	HPH-33700	HE-41700 HE-41710
	<b>Tapón de cicatrización</b>	
Alt. 2mm Alt. 3mm Alt. 4mm Alt. 5mm		HE-41402 HE-41403 HE-41404 HE-41405
	<b>Tornillo</b>	
M1,8 hex. 1.25 M2 hex. 1,20 M2 hex. 1,20 DLC M2 hex. 1.25	HPH-33200	HE-41200 HE-41280 HE-41203
<b>M1,8 Tetralobular ACS</b> <b>M2 Tetralobular ACS</b>	IBO 2901 225	IBO 1102 225
	<b>Calcinable</b>	
Antirrotatorio Rotatorio	HPH-33001 HPH-33010	HE-41001 HE-41010
	<b>Calcinable base Cr-Co</b>	
Antirrotatorio Rotatorio	HPH-33110 HPH-33100	HE-41110 HE-41100
	<b>Chimenea angulada base Cr-Co</b>	
17° 30°	IBO 1102 011	IBO 1102 011 IBO 1102 012

S2 Ø3.3

S3-S4  
Ø3.75 Ø4.1**Scanbody**Intraoral titanio  
Laboratorio Peek

IBO 2901 702

IBO 1102 702  
HE-41770**Interfase 1G**Antirrotatoria  
RotatoriaHE-41751  
HE-41750**Interfase AC 2G**Antirrotatoria alt. 0,5 mm  
Antirrotatoria alt. 1,5 mm  
Antirrotatoria alt. 2,5 mm  
Rotatoria alt. 0,5 mm  
Rotatoria alt. 1,5 mm  
Rotatoria alt. 2,5 mmIBO 1102 620  
IBO 1102 622  
IBO 1102 624  
IBO 1102 621  
IBO 1102 623  
IBO 1102 625**Interfase 3G**Antirrotatoria alt. 0,5 mm  
Antirrotatoria alt. 1,5 mm  
Antirrotatoria alt. 2,5 mm  
Rotatoria alt. 0,5 mm  
Rotatoria alt. 1,5 mm  
Rotatoria alt. 2,5 mm

HPH-33741

HPH-33740

HE-41741  
HE-41743  
HE-41745  
HE-41740  
HE-41742  
HE-41744**Pilar Multiunit**Alt. 1mm  
Alt. 2mm  
Alt. 3mm  
Alt. 4mm  
Alt. 5mm  
Alt. 7mm con tornilloHE-48801  
HE-48802  
HE-48803  
HE-48804  
HE-48805  
HE-48807**Pilar Multiunit angulado**17° alt. 2mm  
17° alt. 3mm  
17° alt. 4mm  
30° alt. 3mm  
30° alt. 4mm  
30° alt. 5mmHE-48852  
HE-48853  
HE-48854  
HE-48863  
HE-48864  
HE-48865**Pilar Lock-Attach**Alt. 0,73mm  
Alt. 1mm  
Alt. 2mm  
Alt. 3mm  
Alt. 4mm  
Alt. 5mm  
Alt. 6mmHPH-33901  
HPH-33902  
HPH-33903  
HPH-33904HE-41901  
HE-41902  
HE-41903  
HE-41904  
HE-41905  
HE-41906Angulado alt. 1,5mm  
Angulado alt. 3mmHE-41951  
HE-41953





# NEODENT®

**CAD/CAM 3400  
CM CONO MORSE®**

**CAD/CAM 3600  
GM GRAND MORSE®**

---

Ibodontit S.L. no guarda relación con ninguna de las marcas aquí referenciadas,  
que son propiedad de sus respectivos titulares

---

**ADT**®  
AXUS  
DENTAL  
TECH



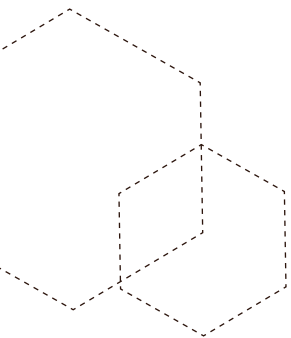

# NEODENT<sup>®</sup> CM CONO MORSE<sup>®</sup>

Ø3.5

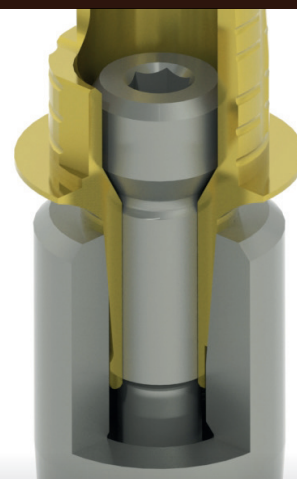

Ø3.5



## Análogo

IBO 3402 300



## Tornillo análogo digital

M1,6 hex. 1,20

HE-41215



## Transfer de impresión

Cubeta abierta (CA)

IBO 3402 350



## Tapón de cicatrización

Alt. 2mm  
Alt. 3,5mm  
Alt. 5mm

IBO 3402 402  
IBO 3402 403  
IBO 3402 404



## Tornillo

M1,8 hex. 0,90  
M1,8 hex. 0,90 DLC

IBO 3402 200  
IBO 3402 280

## M1,8 Tetralobular ACS

IBO 3402 225



## Calcinable

Antirrotatorio  
Rotatorio

IBO 3402 001  
IBO 3402 010



## Calcinable base Cr-Co

Antirrotatorio  
Rotatorio

IBO 3402 110  
IBO 3402 100



## Chimenea angulada base Cr-Co

17°  
30°

IBO 1102 013  
IBO 1102 014

Ø3.5



### Pilar provisional

Antirrotatorio	IBO 3402 550
Rotatorio	IBO 3402 555



### Scanbody

Intraoral titanio	IBO 3402 702
Laboratorio Peek	IBO 3402 700



### Interfase AC 2G

Antirrotatoria	IBO 3402 620
Rotatoria	IBO 3402 621



### Pilar Multiunit

Alt. 1,5mm	IBO 3402 801
Alt. 2,5mm	IBO 3402 802
Alt. 3,5mm	IBO 3402 803
Alt. 4,5mm	IBO 3402 804



### Pilar Multiunit angulado

17° alt. 2,5 mm	IBO 3402 852
17° alt. 3,5 mm	IBO 3402 853
30° alt. 3,5 mm	IBO 3402 864
30° alt. 4,5 mm	IBO 3402 865



### Pilar Lock-Attach

Alt. 2mm	IBO 3402 902
Alt. 3mm	IBO 3402 903
Alt. 4mm	IBO 3402 904
Alt. 5mm	IBO 3402 905

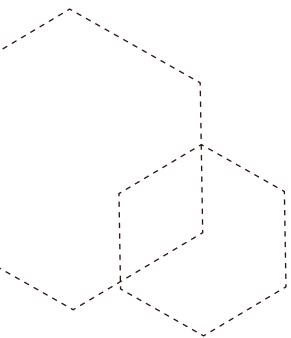

# NEODENT<sup>®</sup> GM GRAND MORSE<sup>®</sup>

Ø3.5 / Ø3.75 / Ø4.0 / Ø4.3 / Ø5.0 / Ø6.0

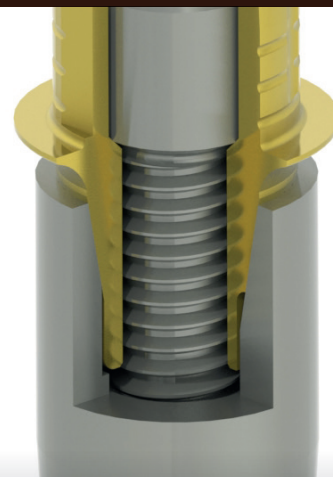

Ø3.5 / 3.75 / 4.0 / 4.3 / 5.0 / 6.0



## Análogo

IBO 3601 300



## Tornillo análogo digital

M1,6 hex. 1,20

HE-41215



## Transfer de impresión

Cubeta abierta (CA)

IBO 3601 350



## Tapón de cicatrización

Alt. 2mm  
Alt. 3,5mm  
Alt. 5mm

IBO 3601 402  
IBO 3601 403  
IBO 3601 405



## Tornillo

M1,6 Neo

IBO 3601 200

M1,6 Tetralobular ACS

IBO 3601 225



## Calcinable base Cr-Co

Antirrotatorio  
Rotatorio

IBO 3601 110  
IBO 3601 100



## Pilar provisional

Antirrotatorio  
Rotatorio

IBO 3601 550  
IBO 3601 555



## Scanbody

Intraoral titanio

IBO 3601 702

Ø3.5 / 3.75 / 4.0 / 4.3 / 5.0 / 6.0



### Interfase AC 2G

Antirrotatoria	IBO 3601 620
Rotatoria	IBO 3601 621



### Interfase 3G

Antirrotatoria alt. 1mm	IBO 3601 601
Antirrotatoria alt. 2mm	IBO 3601 603
Antirrotatoria alt. 3mm	IBO 3601 605
Rotatoria alt. 1mm	IBO 3601 600
Rotatoria alt. 2mm	IBO 3601 602
Rotatoria alt. 3mm	IBO 3601 604



### Pilar Multiunit

Alt. 0,8mm	IBO 3601 800
Alt. 1,5mm	IBO 3601 801
Alt. 2,5mm	IBO 3601 802
Alt. 3,5mm	IBO 3601 803
Alt. 4,5mm	IBO 3601 804
Alt. 5,5mm	IBO 3601 805



### Pilar Multiunit angulado

17° alt. 2,5mm	IBO 3601 852
17° alt. 3,5mm	IBO 3601 853
30° alt. 3,5mm	IBO 3601 863
30° alt. 4,5mm	IBO 3601 864



### Pilar Lock-Attach

Alt. 1mm	IBO 3601 901
Alt. 2mm	IBO 3601 902
Alt. 3mm	IBO 3601 903
Alt. 4mm	IBO 3601 904



# OSSTEM®

CAD/CAM 3000  
TS SYSTEM®

---

Ibodontit S.L. no guarda relación con ninguna de las marcas aquí referenciadas,  
que son propiedad de sus respectivos titulares

---

ADT®  
AXUS  
DENTAL  
TECH



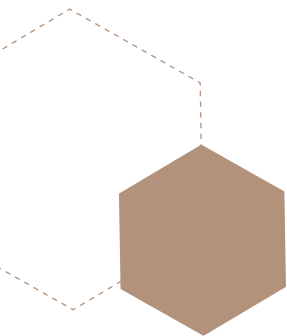

# OSSTEM<sup>®</sup> TS SYSTEM<sup>®</sup>

REGULAR

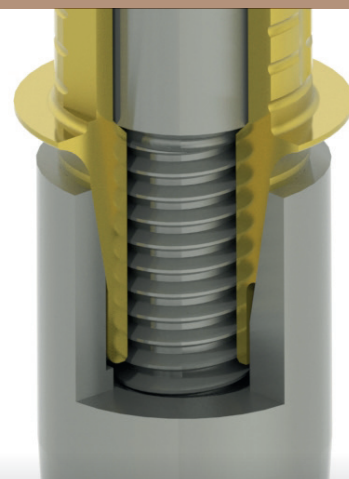

**REGULAR**



## Análogo

IBO 3002 300



## Tornillo análogo digital

M1,6 hex. 1,20

HE-41215



## Transfer de impresión

Cubeta abierta (CA)

IBO 3002 350



## Tapón de cicatrización

Alt. 2mm

IBO 3002 402

Alt. 4mm

IBO 3002 404



## Tornillo

M2 hex. 1.20

IBO 3002 200

M2 Tetralobular ACS

IBO 3002 225



## Calcinable

Antirrotatorio

IBO 3002 001

Rotatorio

IBO 3002 010



## Calcinable base Cr-Co

Antirrotatorio

IBO 3002 110

Rotatorio

IBO 3002 100



## Chimenea angulada base Cr-Co

17°

IBO 1102 011

25°

IBO 1102 015



## Scanbody

Intraoral titanio

IBO 3002 702

Laboratorio Peek

IBO 3002 700



**REGULAR****Interfase AC 2G**

Antirrotatoria	IBO 3002 620
Rotatoria	IBO 3002 621

**Interfase 3G**

Antirrotatoria alt. 1mm	IBO 3002 601
Antirrotatoria alt. 2mm	IBO 3002 603
Antirrotatoria alt. 3mm	IBO 3002 605
Rotatoria alt. 1mm	IBO 3002 600
Rotatoria alt. 2mm	IBO 3002 602
Rotatoria alt. 3mm	IBO 3002 604

**Pilar Multiunit**

Alt. 1,5mm	IBO 3002 801
Alt. 2,5mm	IBO 3002 802
Alt. 3,5mm	IBO 3002 803
Alt. 4,5mm	IBO 3002 804
Alt. 5,5mm	IBO 3002 805

**Pilar Multiunit angulado**

17° alt. 2,5 mm	IBO 3002 852
17° alt. 3,5 mm	IBO 3002 853
30° alt. 3,5 mm	IBO 3002 864
30° alt. 4,5 mm	IBO 3002 865

**Pilar Lock-Attach**

Alt. 1mm	IBO 3002 901
Alt. 2mm	IBO 3002 902
Alt. 3mm	IBO 3002 903
Alt. 4mm	IBO 3002 904
Alt. 5mm	IBO 3002 905



# BEGO®

CAD/CAM 3900  
SC/RS®

---

Ibodontit S.L. no guarda relación con ninguna de las marcas aquí referenciadas,  
que son propiedad de sus respectivos titulares

---

ADT®  
AXUS  
DENTAL  
TECH



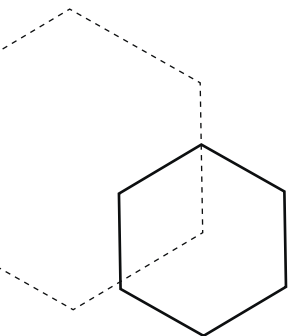

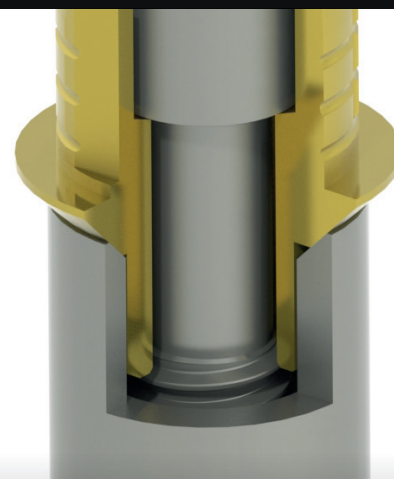

# BEGO<sup>®</sup> SC/RS<sup>®</sup>

Ø3.25 / Ø3.75 / Ø4.1 / Ø4.5



	Ø3.25 - 3.75	Ø4.1	Ø4.5
	<b>Análogo</b>		
	IBO 3901 300	IBO 3902 300	IBO 3903 300
	<b>Tornillo análogo digital</b>		
M1,6 hex. 1,20	HE-41215	HE-41215	HE-41215
	<b>Transfer de impresión</b>		
Cubeta abierta (CA)	IBO 3901 350	IBO 3902 350	IBO 3903 350
	<b>Tapón de cicatrización</b>		
Alt. 3mm	IBO 3901 403	IBO 3902 403	IBO 3903 403
Alt. 5mm	IBO 3901 405	IBO 3902 405	IBO 3903 405
	<b>Tornillo</b>		
M1.8 c/hex. 1.25	IBO 3901 200	IBO 3901 200	IBO 3901 200
<b>M1,8 Tetralobular ACS</b>	IBO 3901 225	IBO 3901 225	IBO 3901 225
	<b>Calcinable base Cr-Co</b>		
Antirrotatorio	IBO 3901 110	IBO 3902 110	IBO 3903 110
Rotatorio	IBO 3901 100	IBO 3902 100	IBO 3903 100
	<b>Chimenea angulada base Cr-Co</b>		
17°	IBO 1102 011	IBO 1102 011	IBO 1102 011
30°	IBO 1102 012	IBO 1102 012	IBO 1102 012
	<b>Pilar provisional</b>		
Antirrotatorio	IBO 3901 550	IBO 3902 550	IBO 3903 550
Rotatorio	IBO 3901 555	IBO 3902 555	IBO 3903 555

	<b>Ø3.25 - 3.75</b>	<b>Ø4.1</b>	<b>Ø4.5</b>
	<b>Scanbody</b>		
Intraoral titanio	IBO 3901 702	IBO 3902 702	IBO 3903 702
	<b>Interfase AC 2G</b>		
Antirrotatoria	IBO 3901 620	IBO 3902 620	IBO 3903 620
Rotatoria	IBO 3901 621	IBO 3902 621	IBO 3903 621
	<b>Interfase 3G</b>		
Antirrotatoria alt. 0,5mm	IBO 3901 601	IBO 3902 601	IBO 3903 601
Antirrotatoria alt. 1,5mm	IBO 3901 603	IBO 3902 603	IBO 3903 603
Antirrotatoria alt. 2,5mm	IBO 3901 605	IBO 3902 605	IBO 3903 605
Rotatoria alt. 0,5mm	IBO 3901 600	IBO 3902 600	IBO 3903 600
Rotatoria alt. 1,5mm	IBO 3901 602	IBO 3902 602	IBO 3903 602
Rotatoria alt. 2,5mm	IBO 3901 604	IBO 3902 604	IBO 3903 604
	<b>Pilar Multiunit</b>		
Alt. 1,5mm	IBO 3901 801	IBO 3902 801	IBO 3903 801
Alt. 2,5mm	IBO 3901 802	IBO 3902 802	IBO 3903 802
Alt. 3,5mm	IBO 3901 803	IBO 3902 803	IBO 3903 803
Alt. 4,5mm	IBO 3901 804		
Alt. 5,5mm	IBO 3901 805		
	<b>Pilar Multiunit angulado</b>		
17° alt. 2,5mm	IBO 3901 852	IBO 3902 852	IBO 3903 852
17° alt. 3,5mm	IBO 3901 853	IBO 3902 853	
30° alt. 3,5mm	IBO 3901 863	IBO 3902 863	IBO 3903 863
30° alt. 4,5mm	IBO 3901 864	IBO 3902 864	
	<b>Pilar Lock-Attach</b>		
Alt. 1mm	IBO 3901 901	IBO 3902 901	IBO 3903 901
Alt. 2mm	IBO 3901 902	IBO 3902 902	IBO 3903 902
Alt. 3mm	IBO 3901 903	IBO 3902 903	IBO 3903 903
Alt. 4mm	IBO 3901 904	IBO 3902 904	IBO 3903 904
Alt. 5mm	IBO 3901 905		

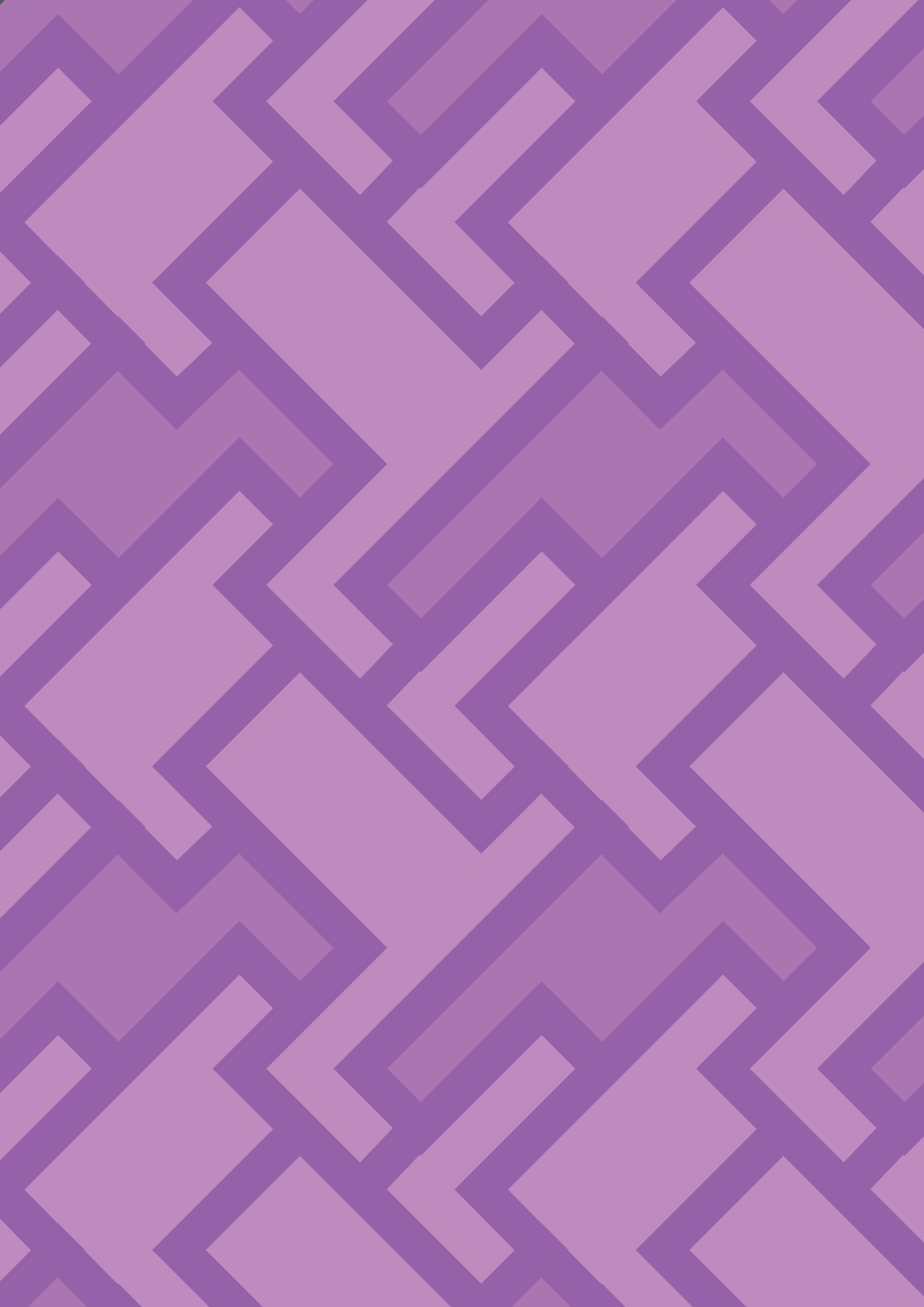

# MEGAGEN®

CAD/CAM 3700  
ANYRIDGE®

---

Ibodontit S.L. no guarda relación con ninguna de las marcas aquí referenciadas,  
que son propiedad de sus respectivos titulares

---

ADT®  
AXUS  
DENTAL  
TECH



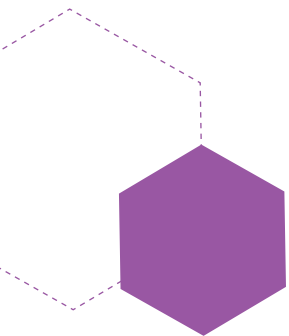

# MEGAGEN<sup>®</sup> ANYRIDGE<sup>®</sup>

Ø4.0



Ø4.0



## Análogo

IBO 3702 300



## Tornillo análogo digital

M1,6 hex. 1,20

HE-41215



## Transfer de impresión

Cubeta abierta (CA)

IBO 3702 350



## Tapón de cicatrización

Alt. 2mm  
Alt. 4mm  
Alt. 6mm

IBO 3702 402  
IBO 3702 404  
IBO 3702 406



## Tornillo

M1,8 hex. 1.20

IBO 3702 200

M1,8 Tetralobular ACS

IBO 3702 225



## Calcinable base Cr-Co

Antirrotatorio  
Rotatorio

IBO 3702 110  
IBO 3702 100



## Pilar provisional

Antirrotatorio  
Rotatorio

IBO 3702 550  
IBO 3702 555



## Scanbody

Intraoral titanio

IBO 3702 702



Ø4.0



### Interfase AC 2G

Antirrotatoria	IBO 3702 620
Rotatoria	IBO 3702 621



### Interfase 3G

Antirrotatoria alt. 1mm	IBO 3702 601
Antirrotatoria alt. 2mm	IBO 3702 603
Antirrotatoria alt. 3mm	IBO 3702 605
Rotatoria alt. 1mm	IBO 3702 600
Rotatoria alt. 2mm	IBO 3702 602
Rotatoria alt. 3mm	IBO 3702 604



### Pilar Multiunit

Alt. 1,5mm	IBO 3702 801
Alt. 2,5mm	IBO 3702 802
Alt. 3,5mm	IBO 3702 803
Alt. 4,5mm	IBO 3702 804



### Pilar Multiunit angulado

17° alt. 2,5 mm	IBO 3702 852
17° alt. 3,5 mm	IBO 3702 853
30° alt. 3,5 mm	IBO 3702 863
30° alt. 4,5 mm	IBO 3702 864



### Pilar Lock-Attach

Alt. 1mm	IBO 3702 901
Alt. 2mm	IBO 3702 902
Alt. 3mm	IBO 3702 903
Alt. 4mm	IBO 3702 904



# INSTRUMENTAL

ADT<sup>®</sup>  
AXUS  
DENTAL  
TECH





# DESTORNILLADORES

## KIT DESTORNILLADOR

8 Puntas + Mango para CLÍNICA



## KIT DESTORNILLADOR

8 Puntas + Mango para LABORATORIO



## KIT DESTORNILLADOR + LLAVE DINAMOMÉTRICA

6 Puntas + Adaptador



## MANGO DESTORNILLADOR

Para CLÍNICA

IN-MAG1005



## MANGO DESTORNILLADOR

Para LABORATORIO

IN-MAG1006



## LLAVE DINAMOMÉTRICA

10 a 60 Ncm + Adaptador para Puntas







IN-LLV1003







## PUNTAS

	CORTA	MEDIANA	LARGA	
PUNTA CUADRADA 1,25	IN-DES1033	IN-DES1034	IN-DES1035	
PUNTA CUADRADA 1,30	IN-DES1036	IN-DES1037	IN-DES1038	
PUNTA CRUZ	IN-DES1021	IN-DES1022	IN-DES1023	
PUNTA UNIGRIP®	IN-DES1024	IN-DES1025	IN-DES1026	
PUNTA TORX	IN-DES1027	IN-DES1028	IN-DES1029	

## PUNTAS

	CORTA	MEDIANA	LARGA	
PUNTA HEXAGONAL 0,90	IN-DES1007	IN-DES1008	-	
PUNTA HEXAGONAL 1,20	IN-DES1009	IN-DES1010	IN-DES1011	
PUNTA HEXAGONAL 1,25	IN-DES1012	IN-DES1013	IN-DES1014	
PUNTA HEXAGONAL 1,27	IN-DES1018	IN-DES1019	IN-DES1020	
PUNTA HEXAGONAL 1,70	IN-DES1015	IN-DES1016	IN-DES1017	
PUNTA PLANA	IN-DES1030	IN-DES1031	IN-DES1032	
ACS	ACS4L20	ACS4L25	ACS4L35	

## DESTORNILLADORES

	CORTO	LARGO	
DESTORNILLADOR Hex 1.20	IN-DES1039	IN-DES1040	
DESTORNILLADOR Hex 1.25	IN-DES1041	IN-DES1042	
DESTORNILLADOR Hex 1.27	IN-DES1043	IN-DES1044	
DESTORNILLADOR TORX	IN-DES1045	IN-DES1046	
DESTORNILLADOR UNIGRIP®	IN-DES1047	IN-DES1048	



## CAJA DE CIRUGÍA

Completa

IN-PLAS1



## CAJA DE CIRUGÍA

Pequeña

IN-PLAS2



## KIT EXTRACTOR COMPLETO

IN-KIT-EXT/L



## MEDIDOR UNIVERSAL

008MB6

RHEIN83



## EXTRACTOR TORNILLOS

Tipo 1

IN-EXT-1



Tipo 2

IN-EXT-2



Tipo 3

IN-EXT-3



Tipo 4

IN-EXT-4



## EXTRACTOR IMPLANTE

## KIT SACATORNILLO

Externo

680BR K

RHEIN83

Interno

680CV

RHEIN83



## FRESA ESPECIAL

Para Kit Sacatornillo

680FS

RHEIN83



Para Escariar

680FA25

RHEIN83



## LLAVE INTERNAL-HEX



MANUAL CORTA

IN-IHCC

MANUAL LARGA

IN-IHCL



TURBINA CORTA

IN-IHTC

TURBINA LARGA

IN-IHTL

## LLAVE PARA REACTIVE®



MANUAL CORTA 3.0

IN-ACMC

MANUAL LARGA 3.0

IN-ACML

MANUAL CORTA 3.5

IN-ACMC35

MANUAL LARGA 3.5

IN-ACML35

MANUAL CORTA 4.3

IN-ACMC43

MANUAL LARGA 4.3

IN-ACML43



TURBINA CORTA 3.0

IN-ACTC

TURBINA LARGA 3.0

IN-ACTL

TURBINA CORTA 3.5

IN-ACTC35

TURBINA LARGA 3.5

IN-ACTL35

TURBINA CORTA 4.3

IN-ACTC43

TURBINA LARGA 4.3

IN-ACTL43

## LLAVE SMARTGRIP



MANUAL CORTA

IN-SGCS

MANUAL LARGA

IN-SGDL



TURBINA CORTA

IN-SGDS

TURBINA LARGA

IN-SGCL

## LLAVE MULTIUNIT®



MANUAL CORTA 2.0

IN-MULMC 2.0

MANUAL CORTA 2.5

IN-MULMC 2.5

MANUAL LARGA 2.0

IN-MULML 2.0

MANUAL LARGA 2.5

IN-MULML 2.5

TURBINA 2.0

IN-MULT 2.0

TURBINA 2.5

IN-MULT 2.5

## LLAVE LOCK-ATTACK

MANUAL CORTA

IN-LOC-MC



TURBINA CORTA

IN-LOC-TC



COMPLETA

IN-LOC-O



## CONECTOR

PARA LLAVE 4X4

IN-ADC



PARA CONTRAANGULO

IN-IMDL



## ADAPTADO DIGITAL

PARA LLAVE 4X4

IN-ADL



## LLAVE CRÍQUET

4X4 MM

IN-RW



EXTENSOR

IN-RE



## DESTORNILLADOR HEXAGONAL 0.048" PARA LLAVE CRÍQUET

CORTO

IN-THDC48



LARGO

IN-THDL48





## TORNILLOS CANAL RECTO

### NOBEL BIOCARE®

PLATAFORMA	Referencia	Asentamiento	Llave	Ø Cabeza	Longitud	Rosca	Torque
BRANEMARK® NP	HE-35200	70	Unigrip®	2.2	7.3	M1.6	35
BRANEMARK® NP	HE-35280	70	Unigrip®	2.2	7.3	M1.6	35
BRANEMARK® RP	HE-41200	90	Hex 1.27	2.4	7.9	M2	25
BRANEMARK® RP	HE-41280	90	Hex 1.27	2.4	7.9	M2	25
BRANEMARK® RP	HE-41201	Plano	Hex 1.20	2.5	8.8	M2	25
BRANEMARK® RP	HE-41202	90	Cuad 1.30	2.4	7.9	M2	25
BRANEMARK® RP	HE-41203	90	Hex 1.25	2.45	7.9	M2	25
BRANEMARK® RP	HE-41204	120	Hex 1.20	2.4	6.5	M2	25
BRANEMARK® RP	HE-41205	120 autoblocante	Hex 1.25	2.45	8	M2	25
BRANEMARK® RP	HE-41206	90	Hex 1.20	2.4	7.9	M2	25
BRANEMARK® RP	HE-41207	90	Unigrip®	2.4	7.9	M2	25
BRANEMARK® RP	HE-41208	90	Hex 1.20	2.45	7.9	M2	35
MULTIUNIT®	HE-48200	Plano	Unigrip®	2	3.5	M1.4	15
MULTIUNIT®	HE-48280	Plano	Unigrip®	2	3.5	M1.4	15
MULTIUNIT®	HE-48206	Plano	Unigrip®	2	3.5	M1.4	15
MULTIUNIT®	HE-48201	Plano	hex 1,27	2	3.5	M1.4	15
BRANEMARK® WP	HE-51200	90	Hex 1.20	3.3	7	M2.5	35
BRANEMARK® WP	HE-51280	90	Hex 1.20	3.3	7	M2.5	35
REPLACE SELECT® 3.5	HEZ-35200	Plano	Unigrip®	2.4	8.3	M1.8	35
REPLACE SELECT® 4.3 / 5.0	HEZ-43200	Plano	Unigrip®	2.4	9.9	M2	35
ACTIVE 3.0	HEC-30200	110	Hex 1.20	1.82	7	M1.4	15
ACTIVE® NP	HE-35200	70	Unigrip®	2.2	7.3	M1.6	35
ACTIVE® NP	HE-35280	70	Unigrip®	2.2	7.3	M1.6	35
ACTIVE® NP	HEC-35206	70	Unigrip®	2.2	7.3	M1.6	35
ACTIVE® RP	HEC-43200	70	Unigrip®	2.45	7.35	M2	35
ACTIVE® RP	HEC-43280	70	Unigrip®	2.45	7.35	M2	35
ACTIVE® RP	HEC-43206	70	Unigrip®	2.45	7.35	M2	35

### ZIMMER®

PLATAFORMA	Referencia	Asentamiento	Llave	Ø Cabeza	Longitud	Rosca	Torque
HEX. INTERNO NP	HEI-35200	90	Hex 1.20	2.1	8.2	M1.8	30
HEX. INTERNO NP /RP / WP	HEI-35201	140	Hex 1.27	1.98	8	UNF1-72	30
HEX. INTERNO NP /RP / WP	HEI-35280	140	Hex 1.27	1.98	8	UNF1-72	30
HEX. INTERNO NP /RP / WP	HEI-35205	120	Hex 1.25	2.1	7.65	M1.8	30
HEX. INTERNO NP /RP / WP	HEI-35206	140	Hex 1.27	1.98	8	UNF1-72	30

### STRAUMANN®

PLATAFORMA	Referencia	Asentamiento	Llave	Ø Cabeza	Longitud	Rosca	Torque
TISSUE LEVEL RN	HI-48200	90	Torx	2.4	7.5	M2	35
TISSUE LEVEL RN	HI-48205	120 autoblocante	Hex 1.205	2.47	8.03	M2	25
TISSUE LEVEL RN SYNOCTA	HI-48201	90	Torx	2.4	4.5	M2	35
TISSUE LEVEL RN / WN	HI-48206	30	Torx	2.58	6.7	M2	35
TISSUE LEVEL RN / WN	HI-48204	30	Torx	2.58	6.7	M2	35
TISSUE LEVEL RN / WN	HI-48280	30	Torx	2.58	6.7	M2	35
BONE LEVEL NC	HI-33200	30	Torx	2.08	7.9	M1.6	35



BONE LEVEL NC	HI-33206	30	Torx	2.08	7.9	M1.6	35
BONE LEVEL NC	HI-33280	30	Torx	2.08	7.9	M1.6	35
BONE LEVEL RC	HI-41200	30	Torx	2.2	7.85	M1.6	35
BONE LEVEL RC	HI-41206	30	Torx	2.2	7.85	M1.6	35
BONE LEVEL RC	HI-41280	30	Torx	2.2	7.85	M1.6	35
BLX 3,5 / 4,5	IBO 3801 200	90	Torx	2,1	6,1	M1.6	30

## ASTRA®

PLATAFORMA	Referencia	Asentamiento	Llave	Ø Cabeza	Longitud	Rosca	Torque
OSSEOSPEED TX 3.0	IBO 2003 200	Plano	Hex 1.27	2.35	7.3	M1.4	15
OSSEOSPEED TX 3.5-4.0	HEA-35200	Plano	Hex 1.27	2.35	8.25	M1.6	20
OSSEOSPEED TX 3.5-4.0	HEA-35280	Plano	Hex 1.27	2.35	8.25	M1.6	20
OSSEOSPEED TX 4.5-5.0	HEA-45200	Plano	Hex 1.27	2.35	10.3	M2	25
UNIABUTMENT® 20°	HEA-35201	Plano	Hex 1.27	2.25	4.8	M1.4	15
EV® 3.0	IBO 3201 200	60	Hex 1.27	2.1	7.3	M1.4	20
EV® 3.6	IBO 3202 200	60	Hex 1.27	2.1	7.3	M1.6	20
EV® 4.2	IBO 3203 200	100	Hex 1.27	2.1	10.3	M1.8	20
EV® 4.8	IBO 3204 200	plano	Hex 1.27	2,3	7,6	M2	20

## BIOMET 3i®

PLATAFORMA	Referencia	Asentamiento	Llave	Ø Cabeza	Longitud	Rosca	Torque
CERTAIN® NP / RP / WP	HEW-34200	Plano	Hex 1.20	2	8.4	M1.6	20
CERTAIN® NP / RP / WP	HEW-34280	Plano	Hex 1.20	2	8.4	M1.6	20
CERTAIN® NP / RP / WP	HEW-34201	90	Hex 1.20	2.27	8.4	M1.6	20
CERTAIN® NP / RP / WP	HEW-34206	Plano	Hex 1.20	2	8.4	M1.6	20
CERTAIN® RP / WP	HEW-41201	90	Hex 1.20	2,3	8,4	M1.6	20
CERTAIN® RP / WP	HEW-41206	90	Hex 1.20	2,3	8,4	M1.6	20
CERTAIN® RP / WP	HEW-41280	90	Hex 1.20	2,3	8,4	M1.6	20
OSSEOTITE® 3,25	IBO 2101 200	Plano	Hex 1.2	2.3	7.5	M1.6	20
OSSEOTITE® 4,1	HE-41200	90	Hex 1.27	2.4	7.9	M2	25
OSSEOTITE® 4,1	HE-41280	90	Hex 1.27	2.4	7.9	M2	25
OSSEOTITE® 5.1	HE-41200	90	Hex 1.27	2.4	7.9	M2	25

## KLOCKNER®

PLATAFORMA	Referencia	Asentamiento	Llave	Ø Cabeza	Longitud	Rosca	Torque
SK2® 4.2	HEV-42200	90	Hex 1.70	2.45	6	M1.8	30
SK2® 4.2	HEV-42201	90	Cruciforme	2,3	4,4	M1.8	30
ESSENTIAL CONE® 4.5	HEV-45200	90	Estrella	2.15	8.2	UNF1-72	30
VEGA 3,5	IBO 4101 200	90	estrella	2,43	8	M1,6	25
VEGA 4,0-4,5	IBO 4102 200	90	estrella	2,32	8	M1,6	25



## TORNILLOS CANAL RECTO

### BTI®

PLATAFORMA	Referencia	Asentamiento	Llave	Ø Cabeza	Longitud	Rosca	Torque
HEX. EXTERNO 3.5	HEB-35200	plano	Hex 1.20	2.57	5.5	M2	20
HEX. EXTERNO 4,1	HE-41200	90	Hex 1.27	2.4	7.9	M2	25
HEX. EXTERNO 3.5 / 4,1	HE-41280	90	Hex 1.27	2.4	7.9	M2	25
INT. UNIVERSAL 4.1 / 5,5	HEB-41200	Plano	Hex 1.20	2.5	7	M1.8	20
INT. UNIVERSAL 4.1 / 5,5	HEB-41206	Plano	Hex 1.20	2.5	7	M1.8	20
INT. UNIVERSAL 4.1 / 5,5	HEB-41280	Plano	Hex 1.20	2.5	7	M1.8	20
INT. UNIVERSAL 4.1 MULTI	HEB-41208	Plano	Hex 1.20	2	3,6	M1.8	20

### MIS®

PLATAFORMA	Referencia	Asentamiento	Llave	Ø Cabeza	Longitud	Rosca	Torque
SEVEN NP	HEM-33200	120	Hex 1.27	2.1	7.6	M1.6	30
SEVEN NP	HEM-33280	120	Hex 1.27	2.1	7.6	M1.6	30
SEVEN SP / WP	HEM-42200	120	Hex 1.27	2.2	7.6	M1.8	30
C1 STANDARD 3,75 / 4,2	IBO 4002 200	120	Hex 1.27	2.2	7.6	M1.8	30

### SWEDEN&MARTINA®

PLATAFORMA	Referencia	Asentamiento	Llave	Ø Cabeza	Longitud	Rosca	Torque
PREMIUM KHONO® 3.3 / 3,8	HES-38200	120	Hex 1.27	2.15	7.45	M1.8	25
PREMIUM KHONO® 3.3 / 3,8	HES-38280	120	Hex 1.27	2.15	7.45	M1.8	25
PREMIUM KHONO® 4.25 / 5,0	HES-43200	120	Hex 1.27	2.5	8.1	M2	25
PREMIUM KHONO® 4.25 / 5,0	HES-43280	120	Hex 1.27	2.5	8.1	M2	25

### DENTSPLY®

PLATAFORMA	Referencia	Asentamiento	Llave	Ø Cabeza	Longitud	Rosca	Torque
FRIADENT XIVE® 3.4 / 3,8 / 4,5	IBO 3102 200	90	Hex 1.20	2	8	M1.6	25
FRIADENT XIVE® 3.4 / 3,8 / 4,5	IBO 3102 280	90	Hex 1.20	2	8	M1.6	25

### BIOHORIZONS®

PLATAFORMA	Referencia	Asentamiento	Llave	Ø Cabeza	Longitud	Rosca	Torque
INTERNAL 3.0	IBO 1601 200	90	Hex 1.27	1.8	8.2	M1.4	15
INTERNAL 3,5 / 4,5	HEI-35201	140	Hex 1.27	1.98	8	UNF1-72	30
INTERNAL 3,5 / 4,5	HEI-35280	140	Hex 1.27	1.98	8	UNF1-72	30

### MICRODENT®

PLATAFORMA	Referencia	Asentamiento	Llave	Ø Cabeza	Longitud	Rosca	Torque
HEX. EXTERNO SYSTEM® 4.2 / 5,1	HE41200	90	Hex 1.27	2.4	7.9	M2	25
HEX. EXTERNO SYSTEM® 4.2 / 5,1	IBO 3302 201	Plano	Hex 1.75	2.4	7.9	M2	30

## OSSTEM®

PLATAFORMA	Referencia	Asentamiento	Llave	Ø Cabeza	Longitud	Rosca	Torque
TS SYSTEM® REGULAR	IBO 3002 200	90	Hex 1.2	2.3	8.4	M2	25

## NEODENT®

PLATAFORMA	Referencia	Asentamiento	Llave	Ø Cabeza	Longitud	Rosca	Torque
CM®	IBO 3402 200	Plano	Hex 0.90	2.4	7.9	M1.8	25
CM®	IBO 3402 280	Plano	Hex 0.90	2.4	7.9	M1.8	25
GRAND MORSE	IBO 3601 200	60	Unigrip	1,86	9,77	M1,6	20

## ANKYLOS®

PLATAFORMA	Referencia	Asentamiento	Llave	Ø Cabeza	Longitud	Rosca	Torque
c/x®	IBO 3502 200	90	Hex 0.90	2.4	7.9	M1.8	20

## PHIBO®

PLATAFORMA	Referencia	Asentamiento	Llave	Ø Cabeza	Longitud	Rosca	Torque
HEXÁGONO EXTERNO 3,3	HPH-33200	120	Hex 1,27	2,25	8	M1,8	25
HEXÁGONO EXTERNO 4,2	HE-41200	90	Hex 1.27	2.4	7.9	M2	25
HEXÁGONO EXTERNO 4,2	HE-41280	90	Hex 1.27	2.4	7.9	M2	25
HEXÁGONO EXTERNO 4,2	HE-41203	90	Hex 1.25	2.45	7.9	M2	25

## BEGO SEMADOS®

PLATAFORMA	Referencia	Asentamiento	Llave	Ø Cabeza	Longitud	Rosca	Torque
3,25-3,75 / 4,1 / 4,5	IBO 3901 200	70	Hex. 1,25	2,35	7,68	M1,8	30

## MEGAGEN ANYRIDGE®

PLATAFORMA	Referencia	Asentamiento	Llave	Ø Cabeza	Longitud	Rosca	Torque
4,0 / 4,5	IBO 3702 200	Plano	Hex.1,2	2,1	8	M1,8	25



## TORNILLOS CANAL ANGULADO

### NOBEL BIOCARE®

PLATAFORMA	Referencia	Asentamiento	Llave	Ø Cabeza	Longitud	Rosca	Torque
BRANEMARK® NP	IBO 1101 225	Plano	ACS	2.3	5.9	M1.6	20
BRANEMARK® RP	IBO 1102 225	Plano	ACS	2.3	6	M2	25
BRANEMARK® WP	IBO 1103 225	Plano	ACS	2.85	6.7	M2.5	25
MULTIUNIT®	IBO 1201 225	Plano	ACS	2.4	3.9	M1.4	15
REPLACE SELECT® 3.5	IBO 1301 225	Plano	ACS	2.3	7.5	M1.8	20
REPLACE SELECT® 4.3	IBO 1302 225	Plano	ACS	2.3	9	M2	25
ACTIVE® NP	IBO 1401 225	70	ACS	2.3	7.3	M1.6	15
ACTIVE® RP	IBO 1402 225	70	ACS	2.3	7.5	M2	20

### ZIMMER®

PLATAFORMA	Referencia	Asentamiento	Llave	Ø Cabeza	Longitud	Rosca	Torque
HEX. INTERNO NP / RP / WP	IBO 1501 225	140	ACS	2.3	7.1	M1.8	20

### STRAUMANN®

PLATAFORMA	Referencia	Asentamiento	Llave	Ø Cabeza	Longitud	Rosca	Torque
TISSUE LEVEL RN / WN	IBO 1801 225	30	ACS	2.6	6.7	M2	25
TISSUE LEVEL RN SYNOCTA	IBO 1801 226	90	ACS	2.3	5.1	M2	25
BONE LEVEL NC / RC	IBO 1902 225	30	ACS	2.3	7.8	M1.6	15
BLX RB / WB	IBO 3801 225	90	ACS	2.3	6.1	M1,6	30

### ASTRA®

PLATAFORMA	Referencia	Asentamiento	Llave	Ø Cabeza	Longitud	Rosca	Torque
OSSEOSPEED TX 3.5-4.0	IBO 2001 225	Plano	ACS	2.3	7.6	M1.6	20
OSSEOSPEED TX 4.5-5.0	IBO 1302 225	Plano	ACS	2.3	9	M2	25
EV® 3.6	IBO 3202 225	60	ACS	2.3	7.2	M1.6	20
EV® 4.2	IBO 3203 225	100	ACS	2.3	7.4	M1.8	20
EV® 4.8	IBO 3204 225	Plano	ACS	2.3	7,6	M1.8	20

### BIOMET 3i®

PLATAFORMA	Referencia	Asentamiento	Llave	Ø Cabeza	Longitud	Rosca	Torque
CERTAIN® NP / RP / WP	IBO 2201 225	Plano	ACS	2.3	6	M2	25
OSSEOTITE®	IBO 1102 225	Plano	ACS	2.3	6	M2	25

### KLOCKNER®

PLATAFORMA	Referencia	Asentamiento	Llave	Ø Cabeza	Longitud	Rosca	Torque
SK2® 4.2	IBO 2301 225	90	ACS	2.3	4.5	M1.8	20
ESSENTIAL CONE® 4.5	IBO 2401 225	90	ACS	2.3	6.7	M1.8	20
VEGA 3,5	IBO 4101 225	90	ACS	2.3	8	M1.8	20
VEGA 4,0-4,5	IBO 4102 225	90	ACS	2,3	8	M1.8	20

## BTI®

PLATAFORMA	Referencia	Asentamiento	Llave	Ø Cabeza	Longitud	Rosca	Torque
HEX. EXTERNO 3.5 / 4,1	IBO 1102 225	Plano	ACS	2.3	6	M2	25
INT. UNIVERSAL 4.1 / 5,5	IBO 2501 225	Plano	ACS	2.3	6.5	M1.8	20
INT. UNIVERSAL 4.1 MULTI	IBO 2501 226	Plano	ACS	2,3	3,6	M1,8	20

## MIS®

PLATAFORMA	Referencia	Asentamiento	Llave	Ø Cabeza	Longitud	Rosca	Torque
SEVEN NP	IBO 1701 225	120	ACS	2.3	6.45	M1.6	20
SEVEN SP / WP	IBO 1501 225	140	ACS	2.3	7.1	M1.8	20
C1 STANDARD 3,75 / 4,2	IBO 1501 225	140	ACS	2.3	7.1	M1.8	20

## SWEDEN&MARTINA®

PLATAFORMA	Referencia	Asentamiento	Llave	Ø Cabeza	Longitud	Rosca	Torque
PREMIUM KHONO 3.3 / 3,8	IBO 2702 225	120	ACS	2.3	6.8	M1.8	20
PREMIUM KHONO 4.25 / 5,0	IBO 2703 225	120	ACS	2.3	6.8	M2	25

## DENTSPLY®

PLATAFORMA	Referencia	Asentamiento	Llave	Ø Cabeza	Longitud	Rosca	Torque
FRIADENT XIVE® 3.4 / 3,8 / 4,5	IBO 3102 225	90	ACS	2.3	8	M1.6	20

## MICRODENT®

PLATAFORMA	Referencia	Asentamiento	Llave	Ø Cabeza	Longitud	Rosca	Torque
HEX. EXTERNO SYSTEM® 4.2	IBO 1102 225	Plano	ACS	2.3	6	M2	25
HEX. EXTERNO SYSTEM® 5.1	IBO 1102 225	Plano	ACS	2.3	6	M2	25

## OSSTEM®

PLATAFORMA	Referencia	Asentamiento	Llave	Ø Cabeza	Longitud	Rosca	Torque
TS SYSTEM® REGULAR	IBO 3002 225	90	ACS	2.3	7.9	M2	25

## NEODENT®

PLATAFORMA	Referencia	Asentamiento	Llave	Ø Cabeza	Longitud	Rosca	Torque
CM®	IBO 3402 225	60	ACS	2.3	4	M1.4	15
GRAND MORSE	IBO 3601 225	60	Unigrip	2,3	9,77	M1,6	20

## ANKYLOS®

PLATAFORMA	Referencia	Asentamiento	Llave	Ø Cabeza	Longitud	Rosca	Torque
C/X®	IBO 3502 225	Plano	ACS	2.3	4.4	M1.6	20



## TORNILLOS CANAL ANGULADO

### PHIBO®

PLATAFORMA	Referencia	Asentamiento	Llave	Ø Cabeza	Longitud	Rosca	Torque
HEXÁGONO EXTERNO 3,3	IBO 2901 225	120	ACS	2,3	8	M1,8	25
HEXÁGONO EXTERNO 4,1	IBO 1102 225	Plano	ACS	2,3	6	M2	25

### BEGO SEMADOS®

PLATAFORMA	Referencia	Asentamiento	Llave	Ø Cabeza	Longitud	Rosca	Torque
3,25-3,75 / 4,1 / 4,5	IBO 3901 225	70	ACS	2,3	7,7	M1,8	30

### MEGAGEN ANYRIDGE®

PLATAFORMA	Referencia	Asentamiento	Llave	Ø Cabeza	Longitud	Rosca	Torque
3,25-3,75 / 4,1 / 4,5	IBO 3702 225	Plano	ACS	2,3	8	M1,8	25

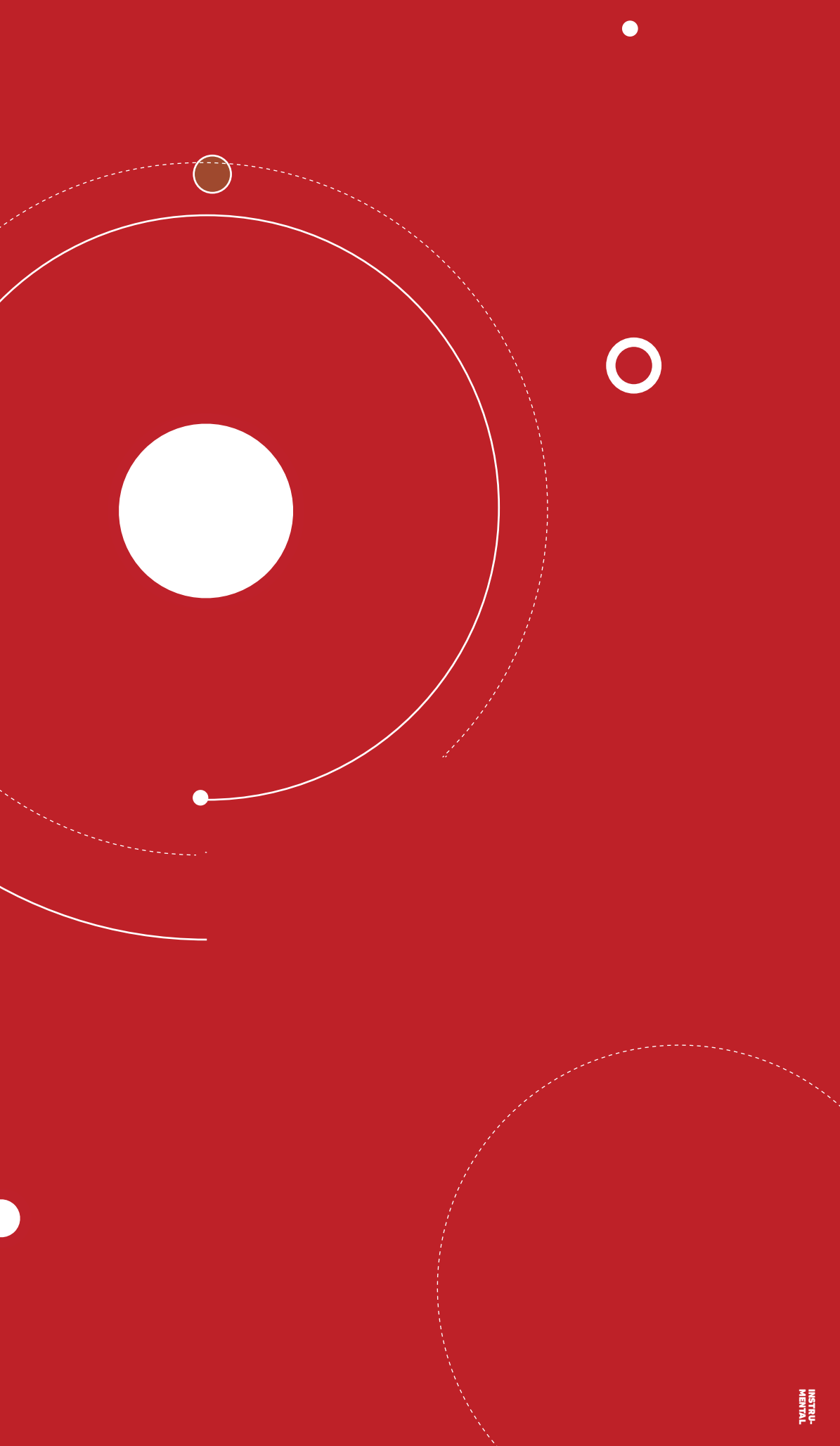

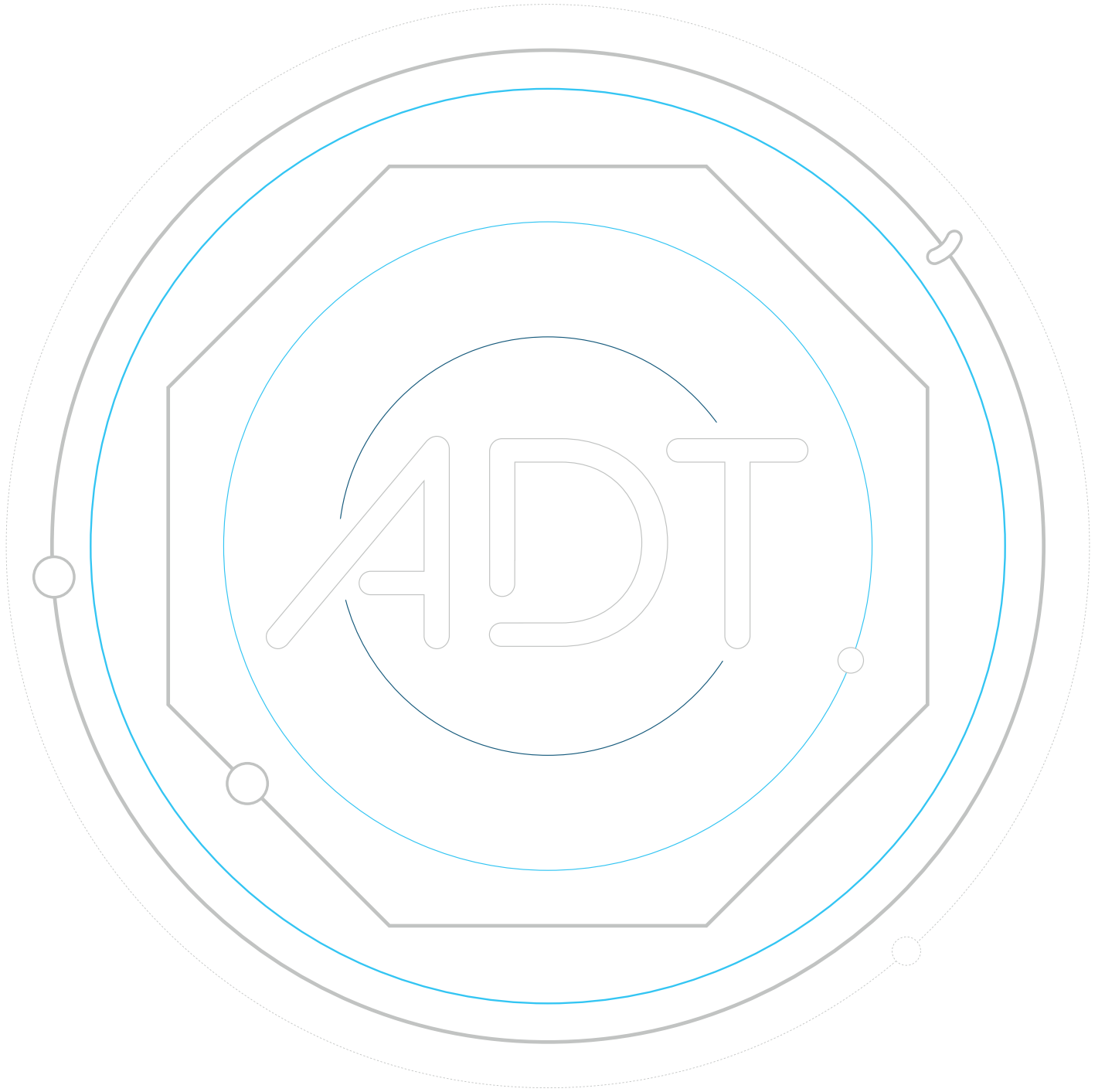

**ADT**®  
AXUS  
DENTAL  
TECH